



IP Office PARTNER Version

IP Office PARTNER Version

Installation and Reference Manual

Notice

While reasonable efforts were made to ensure that the information in this document was complete and accurate at the time of printing, Avaya Inc. can assume no liability for any errors. Changes and corrections to the information in this document may be incorporated in future releases.

Documentation Disclaimer

Avaya Inc. is not responsible for any modifications, additions, or deletions to the original published version of this documentation unless such modifications, additions, or deletions were performed by Avaya.

Link Disclaimer

Avaya Inc. is not responsible for the contents or reliability of any linked Web sites referenced elsewhere within this Documentation, and Avaya does not necessarily endorse the products, services, or information described or offered within them. We cannot guarantee that these links will work all of the time and we have no control over the availability of the linked pages.

License

USE OR INSTALLATION OF THE PRODUCT INDICATES THE END USER'S ACCEPTANCE OF THE TERMS SET FORTH HEREIN AND THE GENERAL LICENSE TERMS AVAILABLE ON THE AVAYA WEBSITE AT <http://support.avaya.com/LicenseInfo/> ("GENERAL LICENSE TERMS"). IF YOU DO NOT WISH TO BE BOUND BY THESE TERMS, YOU MUST RETURN THE PRODUCT(S) TO THE POINT OF PURCHASE WITHIN TEN (10) DAYS OF DELIVERY FOR A REFUND OR CREDIT.

Avaya grants End User a license within the scope of the license types described below. The applicable number of licenses and units of capacity for which the license is granted will be one (1), unless a different number of licenses or units of capacity is specified in the Documentation or other materials available to End User. "Designated Processor" means a single stand-alone computing device. "Server" means a Designated Processor that hosts a software application to be accessed by multiple users. "Software" means the computer programs in object code, originally licensed by Avaya and ultimately utilized by End User, whether as stand-alone Products or pre-installed on Hardware. "Hardware" means the standard hardware Products, originally sold by Avaya and ultimately utilized by End User.

License Type(s): Designated System(s) License (DS).

End User may install and use each copy of the Software on only one Designated Processor, unless a different number of Designated Processors is indicated in the Documentation or other materials available to End User. Avaya may require the Designated Processor(s) to be identified by type, serial number, feature key, location or other specific designation, or to be provided by End User to Avaya through electronic means established by Avaya specifically for this purpose.

Copyright

Except where expressly stated otherwise, the Product is protected by copyright and other laws respecting proprietary rights. Unauthorized reproduction, transfer, and or use can be a criminal, as well as a civil, offense under the applicable law.

Third-Party Components

Certain software programs or portions thereof included in the Product may contain software distributed under third party agreements ("Third Party Components"), which may contain terms that expand or limit rights to use certain portions of the Product ("Third Party Terms"). Information identifying Third Party Components and the Third Party Terms that apply to them is available on Avaya's web site at: <http://support.avaya.com/ThirdPartyLicense/>

Avaya Fraud Intervention

If you suspect that you are being victimized by toll fraud and you need technical assistance or support, call Technical Service Center Toll Fraud Intervention Hotline at +1-800-643-2353 for the United States and Canada. Suspected security vulnerabilities with Avaya Products should be reported to Avaya by sending mail to: securityalerts@avaya.com. For additional support telephone numbers, see the Avaya Support web site (<http://www.avaya.com/support>).

Trademarks

Avaya and the Avaya logo are registered trademarks of Avaya Inc. in the United States of America and other jurisdictions. Unless otherwise provided in this document, marks identified by "®," "TM" and "SM" are registered marks, trademarks and service marks, respectively, of Avaya Inc. All other trademarks are the property of their respective owners.

Documentation information

For the most current versions of documentation, go to the Avaya Support web site (<http://www.avaya.com/support>) or the IP Office Knowledge Base (<http://marketingtools.avaya.com/knowledgebase/>).

Avaya Support

Avaya provides a telephone number for you to use to report problems or to ask questions about your contact center. The support telephone number is 1 800 628 2888 in the United States. For additional support telephone numbers, see the Avaya Web site: <http://www.avaya.com/support>.

Contents

1. Introduction

1.1 How this book is structured.....	8
1.2 RoHS	8
1.3 Repair	9
1.4 Equipment Availability.....	9
1.5 Web Sites	9
1.6 Training	10

2. System Overview

2.1 Partner® Features.....	14
2.2 Partner® Constraints.....	14
2.3 System Components.....	16
2.4 Control Unit.....	17
2.5 SD Card	18
2.6 Base Cards.....	19
2.7 Trunk Cards.....	20
2.7.1 SIP Cards.....	21
2.8 External Expansion Module.....	21
2.9 Supported Phones.....	22
2.10 Dial Plan	22
2.11 Core Software & BIN Files.....	23
2.12 Power Supplies.....	23
2.12.1 Power Supply Backup.....	24

3. Installing PARTNER

3.1 IP Office Manager.....	28
3.2 Getting Started.....	28
3.2.1 Unpacking.....	29
3.2.2 Environmental Requirements.....	29
3.2.3 Read the Documentation.....	30
3.2.4 Space Requirements.....	31
3.2.5 Tools and Parts Required.....	32
3.2.6 Cabling and Cables.....	32
3.2.7 Grounding.....	33
3.2.8 Rack Mounting.....	34
3.2.9 Wall Mounting.....	35
3.3 Install Overview.....	36
3.4 Card Installation.....	37
3.5 Start-up	40
3.6 Connections.....	41
3.7 Final Actions.....	42

4. System Component Details

4.1 Control Unit.....	46
4.1.1 Rear Connections.....	47
4.2 SD Card	48
4.3 Base Cards.....	49
4.3.1 Digital Station.....	50
4.3.2 Analog Phone.....	51
4.3.3 ETR6 Card.....	52
4.3.4 ATM Combination Card.....	54
4.4 Trunk Cards.....	55
4.4.1 Analog Trunk Card.....	56
4.4.2 PRI Trunk Cards.....	56
4.5 Expansion Modules.....	57
4.5.1 Digital Station.....	57

4.5.2 Phone Module.....	59
4.6 Telephones.....	61
4.6.1 1416.....	61
4.6.2 1408.....	62
4.6.3 1403.....	63
4.6.4 ETR34D.....	64
4.6.5 ETR18D.....	65
4.6.6 ETR6D.....	65
4.6.7 ETR34.....	66
4.6.8 ETR18.....	67
4.6.9 ETR6.....	67
4.6.10 3910.....	68
4.6.11 3920.....	68
4.6.12 POTS.....	69
4.6.13 Phone Add-Ons.....	70
4.7 Out of Building Connections.....	71
4.7.1 DS Phones.....	71
4.7.2 Analog Phone Barrier Box.....	72
4.7.3 Rack Mounting Barrier Boxes.....	73
4.8 Associated Applications.....	75
4.8.1 Voicemail.....	75
4.8.2 System Status Application (SSA).....	76
4.8.3 Monitor.....	76
4.8.4 TAPI.....	77
4.8.5 Call Logging Applications.....	78
4.9 Physical Ports.....	78
4.9.1 ANALOG Port.....	79
4.9.2 Audio Port.....	79
4.9.3 DS Ports.....	79
4.9.4 ETR Port.....	80
4.9.5 Expansion Port.....	80
4.9.6 EXT O/P Port.....	80
4.9.7 LAN Port.....	81
4.9.8 PF Port.....	82
4.9.9 Phone (POT) Port.....	82
4.9.10 PRI Port.....	83
4.9.11 RS232 DTE Port.....	84

5. Administration

5.1 Initial Configuration.....	88
5.2 Changing Passwords.....	88
5.3 SD Card Actions.....	89
5.3.1 Removing SD Cards.....	89
5.3.2 Directories and Files.....	90
5.3.3 Booting from the SD Cards.....	91
5.3.4 SD Card Removal.....	91
5.3.5 Recreating an IP Office SD Card.....	92
5.3.6 Backing Up the System SD Card.....	92
5.4 External Trunk Configuration.....	94
5.4.1 Clock Quality.....	94
5.4.2 Unused Trunks.....	95
5.5 Changing Components.....	95
5.5.1 Running SSA.....	97
5.6 Adding Licences.....	97
5.7 Additional Processes.....	98
5.7.1 Upgrading the System.....	98
5.7.2 Upgrading the Core Software.....	99
5.7.3 Changing the IP Address Settings.....	100

5.7.4 System Shutdown.....	101
5.7.5 Rebooting the System.....	102

6. Troubleshooting

7. Appendices

7.1 Safety Statements.....	110
7.1.1 Lightning Protection/Hazard Symbols.....	110
7.1.2 Trunk Interface Modules.....	111
7.1.3 Further Information and Product Updates.....	111
7.1.4 Compliance with FCC Rules.....	111
7.1.5 Port Safety Classification.....	111
7.1.6 EMC Directive.....	112
7.2 Regulatory Instructions for Use.....	113
7.2.1 Canada.....	113
7.2.2 FCC Notification.....	113
Index	115

Chapter 1.

Introduction

1. Introduction

Avaya IP Office Essential Edition - PARTNER Version is a telephone system designed for single site businesses typically with 5 to 25 extensions, that need a small business communications solution which is reliable, established, scalable, easy to use, and can grow as needed. IP Office Essential Edition - PARTNER® Version is an IP / Digital communication system designed exclusively to meet the unique needs of a small business.

This document provides system and component descriptions with details to support configuration and maintenance activities. The main administration and analysis tool used with the Essential Edition - PARTNER Version is the Essential Edition - PARTNER Version admin tool known as [Manager](#) which has its own user manual.

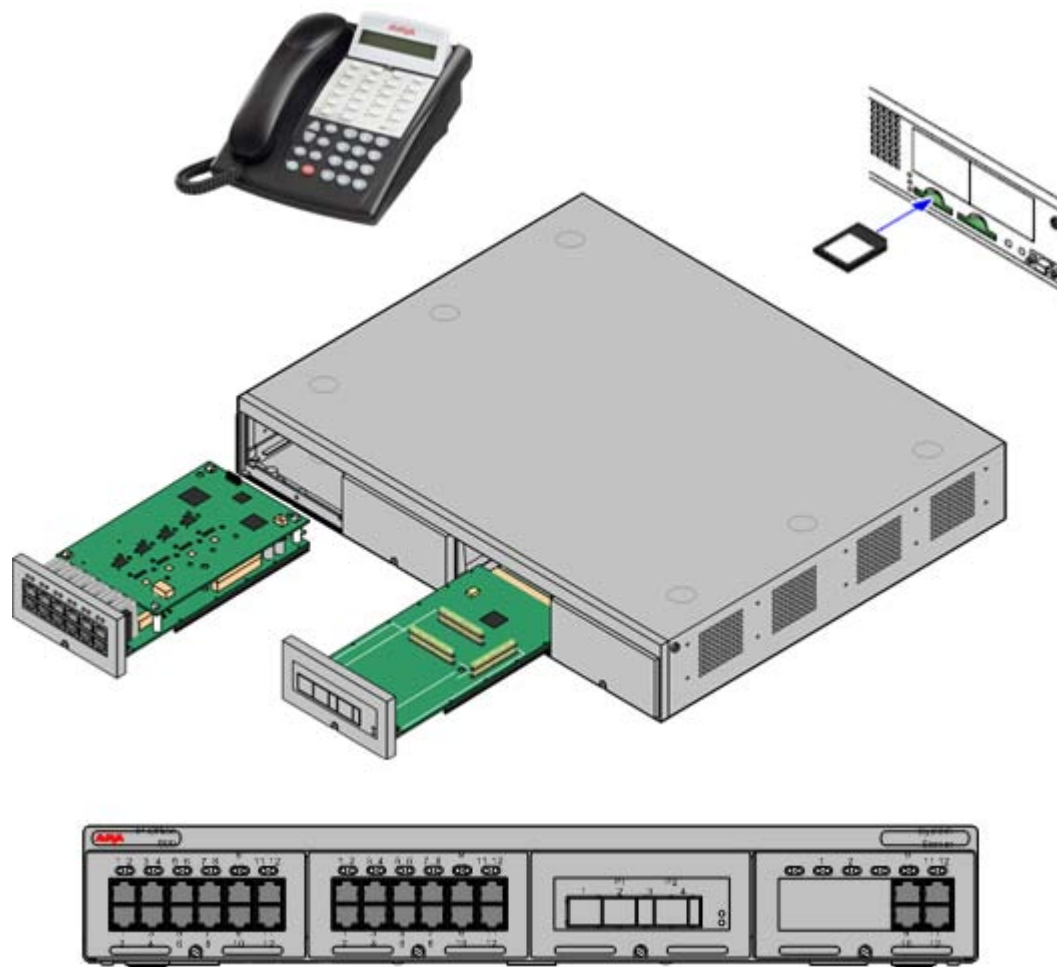

Essential Edition - PARTNER® Version, although physically different, provides the same features and behavior as the Avaya PARTNER® Advanced Communication System (ACS).

The Essential Edition - PARTNER® Version supports a selection of system [telephones](#), many with displays that show you programming and operation feedback. But don't throw that old telephone away, because the Essential Edition - PARTNER Version includes support for many single-line telephones. And you can connect many auxiliary devices, such as fax machines, answering machines, modems, and credit card scanners, to the system.

On-board basic [voice mail](#) eliminates the need for additional hardware.

 Some system configuration actions are protected by the system and are automatically challenged by a password request.

For customers or maintainers who do not have access to the IP Office Manager application, almost all settings described in this document and in the Essential Edition - PARTNER Version Admin Tool User Manual, can be achieved through manual Telephone User Interface (TUI) commands described in the *IP Office PARTNER Version Phone System Administration Guide*.

Associated documents are:

- IP Office Essential Edition - PARTNER® Version - Quick Install Manual
- IP Office Essential Edition - PARTNER® Version - Administrator PC Tool
- IP Office Essential Edition - PARTNER® Version - ETR Phone User Guide
- IP Office Essential Edition - PARTNER® Version - Phone System Administration Guide

IP Office Technical Bulletins

Ensure that you have obtained and read the IP Office Technical Bulletin relating to the Essential Edition - PARTNER Version software release which you are installing. This bulletin will contain important information that may not have been included in this manual. IP Office Technical Bulletins are available from the [Avaya support](http://support.avaya.com) website (<http://support.avaya.com>).

1.1 How this book is structured

This book contains seven chapters, which provide information as follows:

Chapter 1, Introduction — briefly details the installation procedure for Essential Edition - PARTNER Version and provides standard Avaya information.

Chapter 2, System Overview — describes the Essential Edition - PARTNER Version system structure, the system features, modes of operation, system capacities.

Chapter 3, Installing PARTNER® — intended primarily for the technician, explains the physical installation of the control unit and the telephones.

Chapter 4, System Component Details — descriptions of system components identified in Chapter 2, *System Overview*.

Chapter 5, Administration — explains how the system configuration can be altered and how software and hardware can be upgraded as new modules and releases become available.

Chapter 6, Troubleshooting — how to handle problems occurring during installation and operation. Describes possible problems with the telephone system and the solutions to these problems.

Appendices — supplementary information

Index

Document History

Version	Change	Name	Date
Draft 1	Initial issue	V Vella	12 Nov 2009
Draft 2	ER comments	V Vella	20 Nov 2009
Draft 3	Nomenclature correction and edit	V Vella	
Draft 4	First review draft	V Vella	12 Jan 2010
Draft 5	Continued editing and review comments	V Vella	22 Jan 2010
Issue 1.0	Issued for final review	V Vella	1 Feb 2010
Issue 1.a	Pagination	V Vella	11 Feb 2010

Document Conventions

The following font attributes are used in this document:

- **Bold** Used to emphasize, identify commands or highlight menu selections
- *Italic* Used to identify dialog fields, windows, or documents
- `Courier` Used for code listings, file names and command line content

1.2 RoHS

RoHS is a European Union directive for the Removal of Certain Hazardous Substances from Electrical and Electronic Equipment. Similar legislation has been or is being introduced in a number of other countries. Avaya has decided to make its global product range compliant with the requirements of RoHS.

The actions taken vary:

- In some cases equipment has been discontinued and is no longer available from Avaya.
- In some cases new manufactured stock has been made RoHS compliant and keeps its existing Part number.
- In other cases the equipment has been replaced by a new RoHS compliant alternative with new Part numbers.

The Part numbers within this document are for RoHS compliant equipment unless otherwise stated.

1.3 Repair

Essential Edition - PARTNER Version systems do not contain any user serviceable or repairable components. If a faulty unit is suspected the whole unit should be replaced.



IP Office 500v2 [control](#) units should not be opened under any circumstances.

1.4 Equipment Availability

Part numbers and details of specific items within this documentation are for reference only. Items available in any specific locale should be confirmed against the local Essential Edition - PARTNER Version price list for that locale. The local price list may also include additional items relative to the installation requirements of that locale.

1.5 Web Sites

Information to support the IP Office can be found on a number of web sites.

- Avaya - <http://www.avaya.com>
The official web site for Avaya. The front page also provides access to individual Avaya web sites for different countries.
- Avaya Enterprise Portal - <http://partner.avaya.com>
This is the official web site for all Avaya Business Partners. The site requires registration for a user name and password. Once accessed, the site portal can be individually customized for what products and information types you wish to see and to be notified about by email.
- Avaya Support - <http://support.avaya.com>
Contains documentation and other support materials for Avaya products including IP Office. Copies of the IP Office CD images are available from this site and updated core software .bin files.
- Avaya IP Office Knowledge Base - <http://marketingtools.avaya.com/knowledgebase>
Access to an on-line regularly updated version of the IP Office Knowledge Base. Currently this link is only available to Avaya Business Partners while running an ARA account (Avaya Remote Access) connection.
- Avaya University - <http://www.avaya-learning.com>
This site provides access to the full range of Avaya training courses. That includes both on-line courses, course assessments and access to details of classroom based courses. The site requires users to register in order to provide the user with access to details of their training record. See [Training](#).
- Avaya Community - <http://www.aucommunity.com>
This is the official discussion forum for Avaya product users. However it does not include any separate area for discussion of Essential Edition - PARTNER Version issues.
- Avaya UPS Calculator - <http://ups.avayaups.com>
An online calculator for uninterruptible power supply (UPS) requirements. Allows specification of a range of equipment to be supported. See [Power Supply Backup \(UPS\)](#).
- Other Non-Avaya Web Sites
A number of third-party web forums exist that discuss Essential Edition - PARTNER Version. These can act as useful source of information about how the Essential Edition - PARTNER Version is used. Some of these forums require you to be a member and to register. These are not official Avaya forums and their content is not monitored or sanctioned by Avaya.
 - Tek-Tips: <http://www.tek-tips.com>.
 - IP Office Info: <http://www.ipofficeinfo.com>.
 - Yahoo Groups: <http://groups.yahoo.com/group/ipoffice>.
 - Lycos Forum: <http://members.lycos.co.uk/ipoffice>.
 - PBX Tech: <http://www.pbxtech.info/forumdisplay.php?f=8>.

1.6 Training

Avaya University provides a wide range of training courses for IP Office and its associated applications. This includes courses necessary for IP Office resellers to become Avaya Authorized Channel Partners and for individuals to achieve IP Office certification.

Details of all the course can be found on the Avaya University web site (<http://www.avaya-learning.com>). The site can be used to check course availability and to book course. It also includes on-line courses and on-line course assessments. The site requires users to setup a user name and password in order to track their personal training record.

Chapter 2.

System Overview

2. System Overview

This section looks at the components that collectively form the Essential Edition - PARTNER® Version system. This includes aspects such as [cabling](#) and the need for additional non-Avaya IP Office equipment.

 The section provides only a general description of individual units. For greater detail, refer to the [System Components](#) section.

2.1 Partner® Features

The following basic features are provided by Essential Edition - PARTNER® Version:

- Prompts and feedback displays on both ETR and 1400 sets, emulate the PARTNER ACS R8 system.
- Integral [SD card](#) contains system files, and backup files. Automatic backup every 24 hours
- Up to 48 extensions
- Avaya [ETR](#) Telephone support
- Avaya [1400](#) Digital Telephone support
- Key System Functionality
- Embedded [Voicemail](#)
- SIP [Trunking](#) (up to 10 trunks)
- Supports the Essential Edition - PARTNER Version Manager application.
- Supports the [System Status Application](#)
- Supports the [System Monitor Application](#)
- [TAPI](#)
- SMDR
- Supports [DS16 Expansion](#) Module (adds 16 additional digital station ports.) and [Phone16 Expansion](#) Module (adds 16 additional analog station ports)
- 64-party conferencing
- Supports loudspeaker connectivity via a combination card, ETR-6, or one of the built-in POTS port on other cards
- Includes 3 instances of SIP and Mobility.
- Call handling mode will change from key to PBX operation

The following features are pre-assigned:

- Last Number Redial
- Drop
- Recall (CO hook flash)
- Auto Line Selection – L1, L2, etc.
- Voice Mail Access, Each extension has voice mailbox assigned with Automatic Voice Mail Coverage turned on.

Control unit slot availability – (maximum of 4 of the following cards):

- Up to 2 Combination cards (each provides 6 DS ports; 2 POTS station ports; 4 POTS line ports; and 10 VCM channels {supports up to 10 SIP lines})
- Up to 3 Essential Edition - PARTNER Version ETR-6 cards (each provides 6 ETR station ports)
- Up to 3 DS8 cards (each provides 8 digital station ports)
- Up to 3 Phone 8 cards (each provides 8 POTS station ports). Maximum of 3 since a Combination card; DS-8 or ETR-6 must be present in system
- Up to 3 Phone 2 cards (each provides up to 2 POTS station ports). Maximum of 3 since a Combination card; DS-8 or ETR-6 must be present in system
- An ATM4 daughter card can be added to any ETR-6 card or DS card, or Phone card increasing POTS line capacity. (up to max 3)
- 1 PRI/T1 daughter card may be added to any ETR-6 card or DS card or Phone card, increasing digital line capacity.

2.2 Partner® Constraints

[Redacted]	Max allowed in system
IP Office Essential Edition - PARTNER Version Base Cards:	

Phone 8 - Base	3
Phone 2 - Base	3
DS 8 - Base	3
ETR-6 – Base	3
6DS+2POTS+VCM10 LE Combination	2
IP Office Essential Edition - PARTNER Version Daughter Cards:	
ATM 4 Uni - daughter	3
PRI 1 Uni - daughter	1
IP Office Essential Edition - PARTNER Version Expansion Modules:	
IP Office 500v2 PHONE 16	1
IP Office 500v2 DIGITAL STATION 16	1

Essential Edition - PARTNER Version requires a presence of at least 1 ETR or Digital station to be used for TUI administration. This needs the presence of at least 1 of the following cards:

- Combination Card
- DS8
- ETR-6

System capacity for the Essential Edition - PARTNER® Version is flexible and can use combinations of the following hardware components:

Control unit (4 available slots – maximum of 4 of the following cards):

- Up to 2 Combination cards (each provides 6 DS ports; 2 POTS station ports; 4 POTS line ports; and supports up to 10 SIP lines)
- Up to 3 ETR-6 cards (each provides 6 ETR station ports)
- Up to 3 DS8 cards (each provides 8 digital station ports)
- Up to 3 Phone 8 cards (each provides 8 POTS station ports)
 - o Maximum of 3 because a combination card; DS-8 or ETR-6 must be present in system
- Up to 3 Phone 2 cards (each provides up to 2 POTS station ports)
 - o Maximum of 3 because a combination card; DS-8 or ETR-6 must be present in system

An ATM4 daughter card can be added to any ETR card or DS card, or Phone card increasing POTS line capacity. 1 PRI/T1 daughter card may be added to any ETR card or DS card or Phone card, increasing digital line capacity.

One expansion module may be added to the main control unit; providing additional growth capability. The supported expansion modules are:

- DS16 Expansion Module (adds 16 additional digital station ports.)
- Phone 16 Expansion Module (adds 16 additional analog station ports)

Based on these configurations; an Essential Edition - PARTNER® Version may support up to 64 lines (1-PRI; 3 ATM4; up to 10 SIP trunks) and up to 48 stations (Up to 18 ETR stations and/or 46 digital ports + 2 POTS). Maximum growth capabilities are software blocked in the system.

Essential Edition - PARTNER Version will support up to 10 SIP trunks, which can be assigned across multiple SIP service providers.

2.3 System Components

The following are typical components of an Essential Edition - PARTNER® Version system.

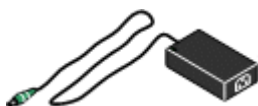
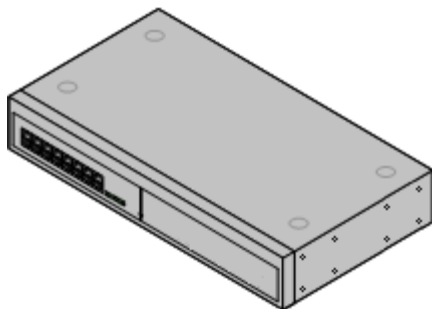
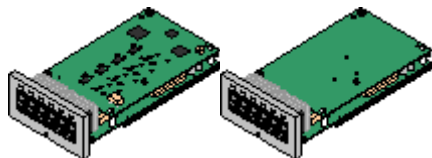
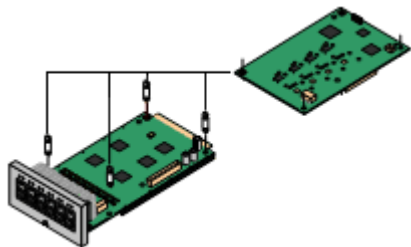
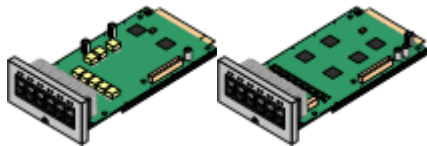
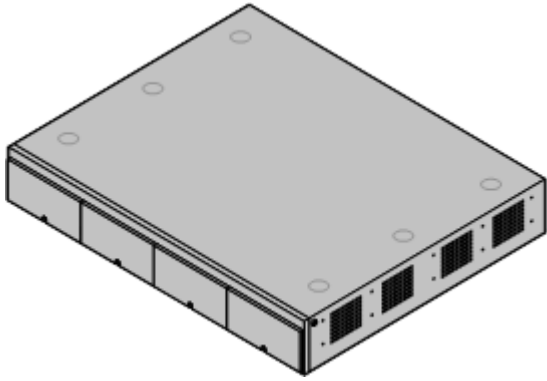

- [IP Office 500v2 Control Unit](#)
The control unit, holds the main configuration and performs the routing and switching for telephone calls and data traffic. The control unit includes a [LAN](#) port, slots for additional internal cards and in some cases cards for additional analog phone ports.
- [SD Card](#)
The IP Office 500v2 control unit uses the Avaya [SD](#) flash memory card which has Essential Edition - PARTNER Version software and Embedded [Voicemail](#) already installed. Each Avaya SD card has a unique serial number.
- [IP Office 500 Base Cards](#)
The control unit has slots for up to four base cards. These can be used to add analog and digital extension ports.
 - IP Office 500 Digital Station Base Card
 - IP Office 500 ATM Combination Card
 - IP Office 500v2 ETR-6 Base Card
 - IP Office 500 Analog Phone Base Card
 - IP Office 500 VCM Base Card
 - IP Office 500 4-Port Expansion Base Card
- [IP Office 500 Trunk Daughter Cards](#)
Some base cards can be fitted with a IP Office 500 daughter card in order to support various types of trunk connections.
 - IP Office 500 Analog Trunk Card
 - IP Office 500 T1/PRI Trunk Card
 - IP Office 500 SIP Trunk Card
- IP Office 500 Combination Cards
These card are pre-paired base and daughter cards. They provide 6 digital station ports, 2 analog phone ports and 4 analog trunks.
- [IP Office 500 External Expansion Modules](#)
Additional analog and digital extension ports can be added using an IP Office 500 external expansion module.
- Only one Digital Station 16 or one Phone 16 module may be used with Essential Edition - PARTNER Version.
- [Power Supplies](#)
The IP Office 500 V2 control unit has an internal power supply unit. Each external expansion module is supplied with an external power supply unit. Additional power supply units may also be required for IP phones and some phone add-ons.

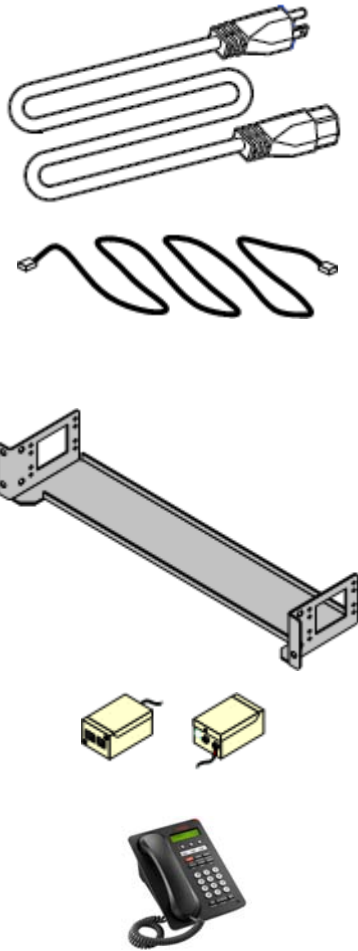

- [Power Cords](#)
Depending on the locale, different power cords need to be ordered for each control unit, external expansion module and any phones or devices using external power supply units.
- [Cables](#)
The Essential Edition - PARTNER Version is designed primarily for connection to a structured cabling system using CAT3 UTP cabling. This approach allows telephone and data traffic to share the same wiring infrastructure and simplifies equipment moves.
- [Mounting Kits](#)
The IP Office 500v2 control unit can be used free-standing, with an external expansion module stacked above it. With optional rack mounting kits, the control unit and external expansion module can also be rack mounted. Alternatively with an optional wall mounting kit the control unit can be wall mounted.
- [Surge Protectors and Barrier Boxes](#)
Where the installation includes extensions in other buildings additional protective equipment is required. This equipment may also be required in areas where the lightning risk is high.
- [Phones](#)
Essential Edition - PARTNER Version systems support a variety of Avaya digital and wireless phones plus analog phones.

2.4 Control Unit

The base item of the Essential Edition - PARTNER Version system is the system server or control unit. It stores the system configuration and controls system operation. Essential Edition - PARTNER Version uses the IP Office 500v2 R6.0 control unit or above.

A control unit can be customized by adding various internal cards such as trunk cards. external expansion modules can be also be connected to add additional extension and trunk ports.

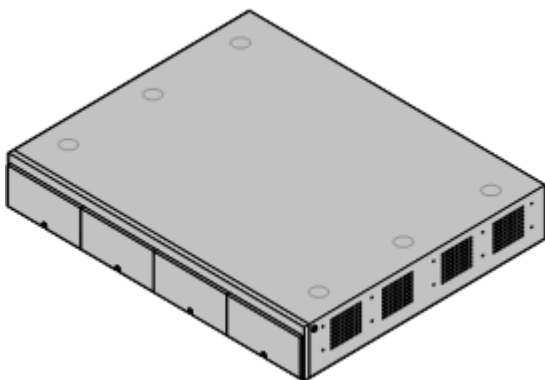

The IP Office 500v2 control unit has four front slots for [IP Office 500 base cards](#). It has an internal power supply unit and uses a mandatory dongle in the form of an SD Card plugged into a rear panel slot. It includes a 2 port ethernet [LAN](#) switch (layer 3 managed) on the rear.

The following table summarizes the capacities of the control unit supported by Essential Edition - PARTNER Version software.

Feature	Provision
Control Unit Digital Station Ports	Up to 30
Control Unit Analog Phone Ports	Up to 26

Control Unit ETR Phone Ports	18
Embedded Voicemail Card	✓
Integral WAN Port	Not used
External Expansion Ports	1
Audio In (MOH) Port	✓
External O/P Switch Port	✓
Conference Parties	64
Maximum Extension Capacity	48
Digital Phones only.	46
Analog Phones only.	42
ETR Phones only.	18
IP500 Trunk Daughter Cards	
IP500 Analog trunks	✓ 12
IP500 PRI trunk channels	✓ 24
VCM Cards	
IP500 VCM Cards	2**
Dimensions	
Height x Width x Depth	73x445x365mm 2.9"x17.5"x14.4"

** Only supports VCM channels provided by fitting IP500 Combination cards.

2.5 SD Card

The Avaya SD card exercises central control over the Essential Edition - PARTNER Version system and acts as the License dongle for the control unit. The SD card is inserted into the System SD slot on the rear of the control unit. Except during maintenance the System SD slot should contain an Avaya SD card at all times. The files on that card are used when the system is started and the Feature Key serial number only present on Avaya cards is used for the licensing of Essential Edition - PARTNER Version features.

System SD

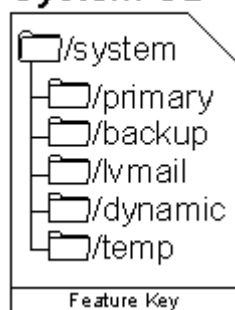

- The SD card stores system files, the system status application (SSA) and a voice mail application providing 2 channels by default but can be licensed for up to 6 channels total.
- The system SD card is also used to store copies of core software binary files, configuration files and backups.
- Various commands within Manager interface enables the SD card contents to be backed up, restored or copied.
- The control unit has an Optional SD slot as well as the System SD slot. This Optional SD card slot can be used to store occasional full copies of the System SD card. or as an additional memory card to or from which, files can be copied. Non-Avaya cards can be used for this as long as they conform to the standard below:
 - SDHC minimum 4GB FAT32 format (Single partition, SDHC, class2+, FAT32, SPI & SD bus).



SD Card Removal

SD cards should never be removed while being used. Though the SD card slot LEDs indicate when data is being written to an SD card, lack of flashing LED is not a sufficient safeguard. The IP Office Manager provides methods to [shutdown and restart an individual card](#) or to [shutdown the](#) Essential Edition - PARTNER Version system in order to allow removal of an SD card. If the System SD card is removed, licensed features will continue operating for up to 2 hours.

2.6 Base Cards

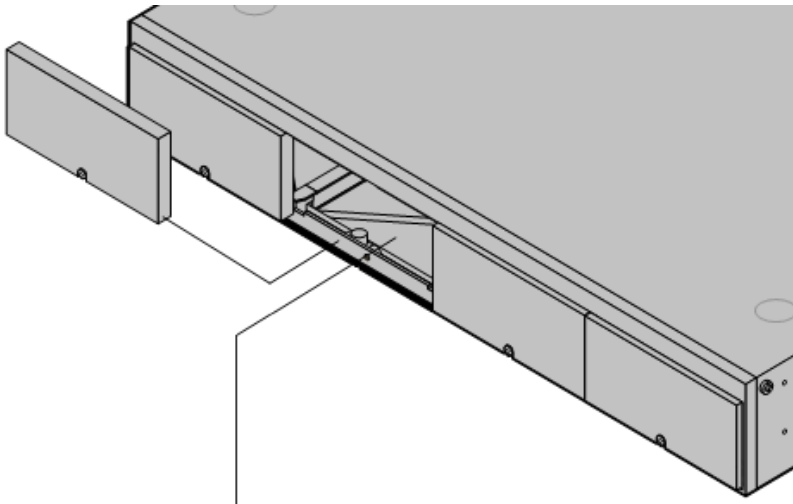

The IP Office 500v2 control unit has 4 slots to accommodate base cards. Each base card includes an integral front panel with ports for cable connections.

The slots are numbered 1 to 4 from left to right. Normally they can be used in any order, however if the capacity for a particular type of card is exceeded, the card in the highest slot will be disabled.

[IP Office 500 Analog Phone Base Card](#)

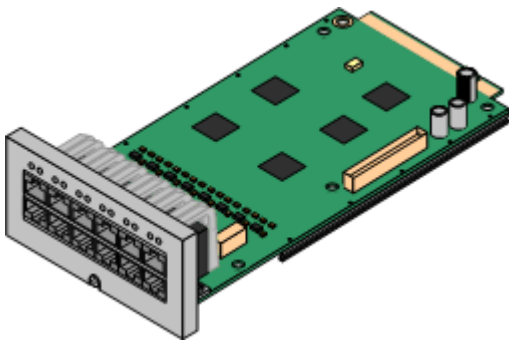

This card has 12 RJ45 ports. The card is available in two variants, providing 2 or 8 analog extension ports for the connection of analog phones. The card can be fitted with an IP Office 500 daughter card which then uses the additional 4 RJ45 ports for connections.

- This card accepts one IP Office 500 daughter card of any type supported by Essential Edition - PARTNER Version. See [Constraints](#).
- Maximum: 4 per control unit.
- When fitted with an IP Office 500 Analog Trunk daughter card, the Phone 8 base card supports 1 power failure extension to trunk (loop-start only) connection.
- The analog extension ports do not include a ringing capacitor. Where this is a requirement, connection should be via a Master socket containing ringing capacitors.

[IP Office 500 ATM Combination Card](#)

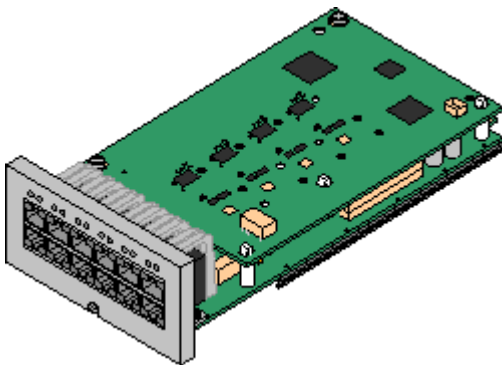

This card provides 6 digital station ports (1-6), 2 analog extension ports (7-8) and 4 analog trunk ports (9-12). The card also includes 10 VCM channels.

- This card has a pre-installed IP Office 500 ATM daughter card.
- Maximum: 2 combination cards per control unit.
- During power failure port 8 is connected to port 12.

[IP Office ETR-6 Base Card](#)

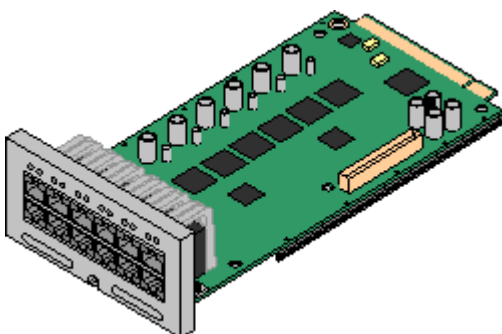

This card is only supported in an IP Office 500v2 control unit running in PARTNER® Version mode. It provides 6 ETR ports for connection of ETR phones. 2 Analog extension ports are also provided for emergency use only with an analog trunk card.

- The card can be fitted with an IP500 trunk daughter card which uses the base card ports for trunk connection.
- Maximum: 3 per control unit.
- The analog phone ports do not include a ringing capacitor. Where this is a requirement, connection should be via a Master socket containing ringing capacitors.
- If fitted with an IP Office 500 Analog Trunk daughter card, during power failure phone ports 7 and 8 are connected to analog trunk port 12. However during normal operation analog phone ports 7 and 8 are not useable.

IP500 Digital Station Base Card

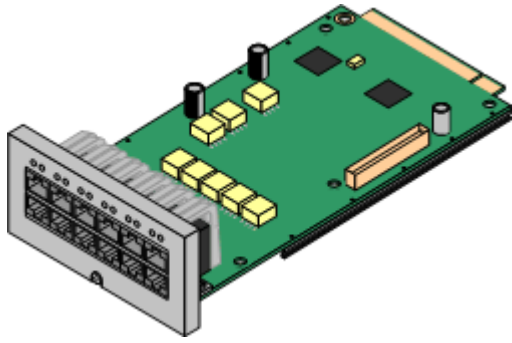

This card provides 8 DS (digital station) ports for the connection of Avaya digital phones other than IP phones.

- The card can be fitted with an IP Office 500 trunk daughter card which uses the base card ports for trunk connection.
- Maximum: 3 per control unit.
- 4400 Series phones (4406D, 4412D and 4424D) are not supported on this card. They are supported on an external expansion module.

2.7 Trunk Cards

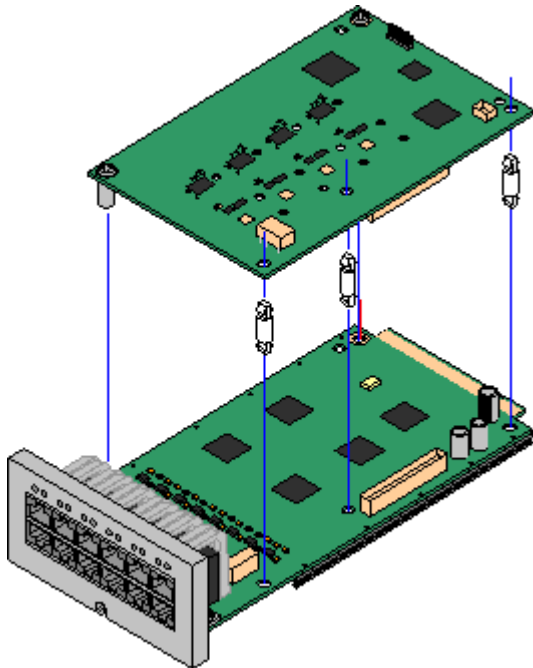

IP Office 500 daughter trunk cards can be fitted to IP Office 500 base cards to provide support for trunk. The daughter card uses the physical ports provided on the front panel of the base card for cable connection.

The addition of an IP Office 500 daughter card is supported on any IP Office 500 base card except the IP Office 500 Legacy Card Carrier base card.

For those base card that support daughter cards, there are no restrictions on the combination of card types. However in systems with both analog phone base cards and analog trunk daughter cards, combining the two types is recommended as it then provides analog power failure support for one trunk/extension.

Each daughter card is supplied two pre-fitted metal pillars and 3 plastic pillars. Two screws and washers for final attachment of the metal pillars to the base card are also included.

IP Office 500 Analog Trunk Daughter Card

This card can be added to IP Office 500 base cards. It enables that base card to then also support four analog loop-start trunks.

- When fitted to an IP Office 500 Analog Phone 8 base card, the combination supports 1 power failure extension to trunk (loop-start only) connection.
- Maximum: 2 per IP Office 500v2 control unit.

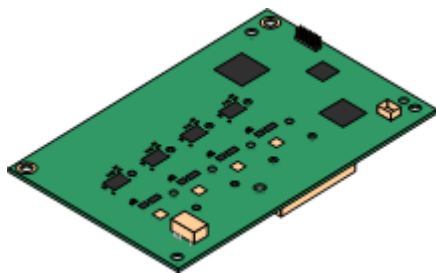

IP Office 500 PRI-U Trunk Daughter Card

This card can be added to an IP Office 500 base card. The card is a universal card that can be configured in software for T1 robbed bit, T1 PRI or E1R2. The card is available in single and dual port variants.

- Maximum: 4 per IP Office 500v2 control unit.
- The IP Office 500 PRI-U card supports E1, T1 and E1-R2 PRI modes. The Essential Edition - PARTNER Version system supports 8 unlicensed B-channels on each IP Office 500 PRI-U port fitted. Additional B-channels, up to the capacity of ports installed and PRI mode selected require IP Office 500 Universal PRI (Additional Channels) licenses added to the configuration. These additional channels consume the licenses based on which additional channels are configured as in-service from port 9 of slot 1 upwards. D-channels are not affected by licensing.

2.7.1 SIP Cards

Essential Edition - PARTNER Version supports SIP trunks. Because there is a wide variety of SIP devices and interpretations of standards, Avaya cannot give any guarantees of support for all SIP features.

SIP Trunk Providers

Essential Edition - PARTNER Version SIP trunks have been successfully tested with the following ITSP SIP providers. This table of providers is a statement of fact and not any form of recommendation from Avaya, nor does it exclude other service providers. Any details of the expected operation and service should be confirmed in writing with the individual service provider.

The SIP Gate service does not support RFC2833 for the sending of DTMF tones. SIP Gate uses the alternate SIP INFO method which is not supported by Essential Edition - PARTNER Version.

Essential Edition - PARTNER Version supports SIP trunks using UDP or TCP. For UDP SIP, STUN is supported for NAT Firewall traversal. Otherwise use of a service provider supporting Session Border Control (SBC) is required. TURN, sometimes used for TCP SIP traversal of NAT firewalls, is not supported.

The Essential Edition - PARTNER Version implementation of SIP conforms to the following SIP RFCs.

RFRFC	Description
2833 [7]	RTP Payload for DTMF digits, telephony tones and telephony signals.
3261 [8]	SIP Session Initiation Protocol.
3264 [11]	An Offer/Answer Model with Session Description Protocol (SDP).
3323 [14]	A Privacy Mechanism for SIP
3489 [18]	STUN - Simple Traversal of User Data gram Protocol (UDP) Through Network Address Translators (NATs).
3824 [24]	Using E.164 Numbers with the Session Initiation Protocol (SIP). E.164 is the ITU-T recommendation for international public telecommunication numbering plans.

2.8 External Expansion Module

This module can be used to add extra ports to a Essential Edition - PARTNER Version system. Only one external expansion unit is supported

- The external expansion module is supplied with a blue 1 meter (3'3") expansion interconnect cable. This cable must be used when connecting to expansion ports on the rear of a control unit.

Each module uses an external [power supply unit](#) supplied with the module. A locale specific [power cord](#) for the PSU must be ordered separately.

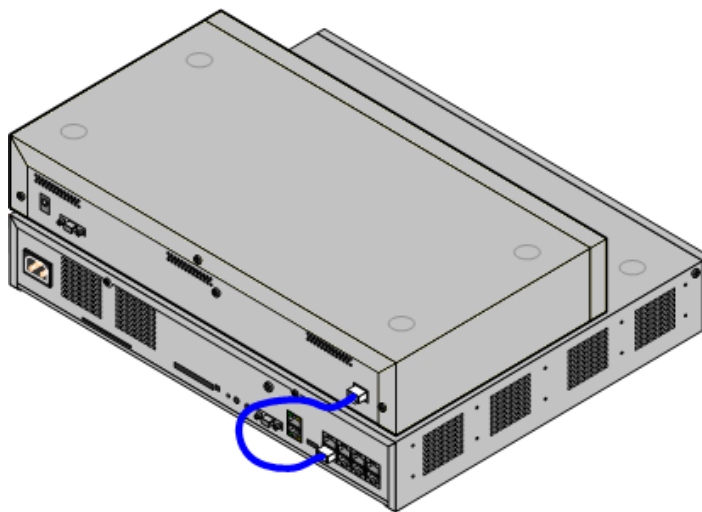

- [IP Office 500 Digital Station Module](#)

Provides an additional 16 DS ports for supported [Avaya digital phones](#).

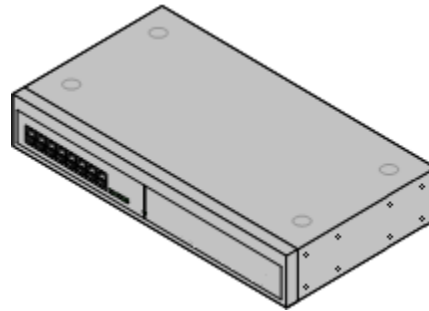

- [IP Office 500 Phone Module](#)

Provides an additional 16 PHONE ports for analog phones.

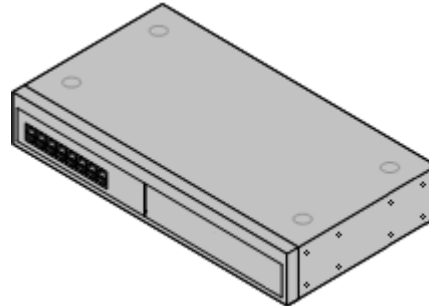

2.9 Supported Phones

Essential Edition - PARTNER Version supports the following phones and phone add-ons. Availability may be subject to local restrictions.

- [ETR 34](#), [18](#), [6](#), [34D](#), [18D](#), [6D](#)
- [3910](#), [3920](#)
- [1403](#), [1408](#), [1416](#)
- [POTS](#) telephones. Essential Edition - PARTNER Version supports the AVAYA 62XX range
- [BM32 Buttons](#)
- Digital station connects to the Essential Edition - PARTNER Version via a DS port.

2.10 Dial Plan

Essential Edition - PARTNER Version has a fixed 2-digit dial plan. The extensions are numbered from 10 to 57 which constitutes a 2 digit dial plan. Short codes are used to access the different features:

- 6 – Call Pickup
- 66 – Group Call Pickup
- 68 – Directed Line Pickup
- 7 – Group access
- 8 – Idle Line Pickup

The dial plan below identifies the valid digit sequences that can be dialled from Essential Edition - PARTNER® Version:

0	Dial Physical Extn [1st Port]
10-57	Station extensions
610-657	Directed call pickup
661-664	Group call pickup (pickup groups 1-4)
6801-6864	Directed line pickup
70	Loudspeaker Page
*71-74	Group calling (calling groups 1-4)
76	Modem (RAS port)
*771-776	Hunt group (hunt groups 1-6)
777	Voicemail Collect
778	Remote Voicemail access

7801	Auto Attendant access
7811	Record Auto Attendant Morning Greeting
7821	Record Auto Attendant Afternoon Greeting
7831	Record Auto Attendant Evening Greeting
7841	Record Auto Attendant Menu Greeting
7851	Record Auto Attendant Out of Hours Greeting
801-864	Idle line pickup
9	Dial access to Idle Line Preference
*	Voice signal (Intercom only)
*70	Loudspeaker Page + Page Calling Group 1

2.11 Core Software & BIN Files

Each IP Office 500v2 control unit and expansion module contains and runs its own part of the IP Office core software. These parts take the form of `.bin` files (binary files).

The Essential Edition - PARTNER Version control unit is supplied with a base level of IP Office software that acts as a software loader for upgrading the unit to the required software level. This software loader supports the [LAN](#) connection necessary for local PC to IP Office upgrade. See *IP Office Manager Essential Edition - PARTNER Version Administrator PC User Guide*.

The `.bin` files for each IP Office software level are included on the Essential Edition - PARTNER Version [SD Card](#) for that software level. They are installed from that SD as part of the Essential Edition - PARTNER Version [Manager](#) application. Manager can then be used to upgrade the `.bin` files loaded in the modules within a system.

Updated sets of software and bin files may also be made available through the Avaya support web site. See [Web Sites](#).

- Software Level

The IP Office core software level is expressed in the form X.Y(Z), for example 2.1(27), where X is the major software level, Y is the minor level and Z is the build number.

The following rules apply to the core software level used by modules within an Essential Edition - PARTNER Version system and between linked IP Office systems.

- All modules within an Essential Edition - PARTNER Version should run the same level of core software. Doing otherwise will lead to incorrect operation of the system.

Upgrading

[Upgrading](#) is performed using the Upgrade Wizard tool within the Essential Edition - PARTNER Version [Manager](#) application (File | Advanced | Upgrade). It displays the systems it can detect, their existing software level and the levels it has available.

- Check IP Office Technical Bulletins

Whenever upgrading check the latest IP Office Technical Bulletins for the various IP Office software releases involved before proceeding. These may contain information relating to changes that occurred after this document was completed. Bulletins are available from <http://support.avaya.com>.

- Multi-Stage Upgrades

The upgrade path may require several intermediate upgrades. Skipping an intermediate level may lead to incorrect system operation and configuration corruption. Multi-stage upgrades are only necessary for control units. External expansion modules can be upgraded directly between any two levels supported by the module.

2.12 Power Supplies

Each [control unit](#) and [expansion module](#) has an internal power supply unit that requires a switched power outlet socket rated at 110-240V ac, 50-60Hz. Connection from that power outlet socket requires an appropriate locale specific power cord which is not supplied with the unit and must be ordered separately.

External expansion modules are supplied with an external power supply unit (PSU). These external power supply units include an integral 1.5 meter lead for connection to the control unit or expansion module. A power cord for connection from the PSU to the power outlet is not included as this varies by locale. The appropriate power cord must be ordered separately or sourced locally.

Power cords must not be attached to the building surface or run through walls, ceilings, floors and similar openings. Installation measures must be taken to prevent physical damage to the power supply cord, including proper routing of the power supply cord and provision of a socket outlet near the fixed equipment or positioning of the equipment near a socket outlet.

For locales not detailed below an appropriate power cord must be obtained locally.

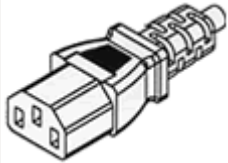
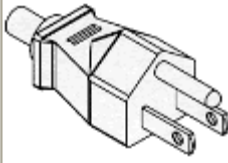
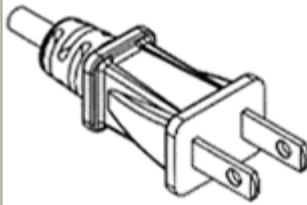
Power Cord Type	Power Outlet Plug Type	Locales	Part number
Earthed Power Cords (IEC60320 C13)  Control Units <ul style="list-style-type: none"> • IP Office 500. IP Office 500 External Expansion Modules <ul style="list-style-type: none"> • Digital Station 16. • Phone 16. 	NEMA5-15P / CS22.2 No.42 	North, Central and South America.	700289770
	NEMA1-15 	North, Central and South America.	700213390

2.12.1 Power Supply Backup

The use of an Uninterrupted Power Supply (UPS) with any telephone system is recommended. Even at sites that rarely lose electrical power, that power may occasionally have to be switched off for maintenance of other equipment. In addition, most UPSs also provide an element of power conditioning, reducing spikes and surges.

The capacity of UPS systems and the total equipment load the UPS is expected to support are usually quoted in VA. Where equipment load is quoted in Watts, multiply by 1.4 to get the VA load.

The calculation of how much UPS capacity is required depends on several choices.

- What equipment to place on the UPS?
Remember to include server PCs such as the voicemail. It is recommended that the total load on a new UPS is never greater than 75% capacity, thus allowing for future equipment.
- How many minutes of UPS support is required?
Actual UPS runtime is variable, it depends on what percentage of the UPSs capacity the total equipment load represents. For example, a 1000VA capacity UPS may only support a 1000VA (100%) load for 5 minutes. This relationship is not linear, the same UPS would support a 500VA (50%) load for 16 minutes. Therefore the lower the percentage of capacity used, the increasingly longer the UPS runtime, typically up to 8 hours maximum. Remember also that for most UPSs the ratio of discharge to full recharge time is 1:10.
- How many output sockets does the UPS provide?
Multiple UPS units may be required to ensure that every item of supported equipment has its own supply socket.

The web site <http://powerquality.eaton.com/AVAYA/default.asp?cx=101> provides a calculator into which you can enter the equipment you want supported on a UPS. It will then display various UPS options. The site uses VA values for typical Essential Edition - PARTNER Version systems. However, if more specific values are required for a particular system, the table below can be used to enter values.

Typical IP Office System	VA
IP Office System	230
Individual Equipment	VA
Phone 8 Module	17
Typical Server PC	600
Typical Desktop PC	400
Mid Span PSU - 6 ports	150
Mid Span PSU - 12/24 ports	300

Chapter 3.

Installing PARTNER

3. Installing PARTNER

This section is intended to assist with the installation of the core components of an Essential Edition - PARTNER Version telephone system. It describes those components and factors that should be considered for an installation.

- The Essential Edition - PARTNER Version is a converged voice and data communications system. It should therefore only be installed by persons with telephony and IP data network experience.
- Installers must be trained on IP Office systems. Through its Avaya University (<http://www.avaya-learning.com>), Avaya provides a range of training courses including specific Essential Edition - PARTNER® Version implementation and installation training. It also provides certification schemes for installers to achieve various levels of IP Office accreditation. See [Training](#).
- It is the installer's responsibility to ensure that all installation work is done in accordance with local and national regulations and requirements. It is also their responsibility to accurately establish the customer's requirements before installation and to ensure that the installation meets those requirements.
- You should read and understand this documentation before installation. You should also obtain and read the Avaya Technical Bulletins relevant to recent Essential Edition - PARTNER® Version software and hardware releases to ensure that you are familiar with any changes to the equipment and software.

 Quick installation instructions are contained in a separate document.



3.1 IP Office Manager

Installation and maintenance of Essential Edition - PARTNER Version can be performed through telephone system TUI commands described in the *Avaya IP Office Essential Edition - PARTNER Version Admin PC Guide*. However the Manager application provides a comprehensive and easy to use interface for installation and maintenance.

The IP Office Essential Edition - PARTNER Version Admin PC Tool (Manager) is an application for viewing and editing an IP Office system configuration. It is a tool meant primarily for system installers and maintainers. Manager runs on a Windows PC and connects to the Essential Edition - PARTNER Version control unit via the Ethernet [LAN](#) connection.

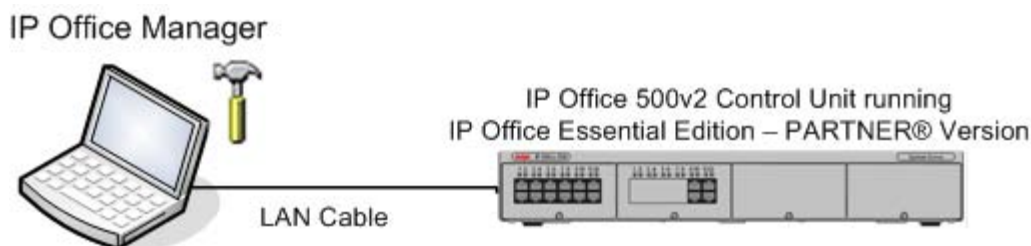
Office manager can be used to prepare user lists, permissions, group memberships and other administration tasks on the telephone system. Manager has its own Administrator User Manual containing comprehensive user instructions.



-  **CAUTION** - Password [Change](#) Required
New IP Office systems use default security settings so you should change the default Remote/Administrator Password. Failure to do so will render the Essential Edition - PARTNER Version system potentially insecure.
-  **IMPORTANT**
Manager is an off-line editor. It receives a copy of the current configuration settings for the Essential Edition - PARTNER Version system, from the control unit [SD Card](#). Changes may be made to that copy and it is then sent back to the SD Card for those changes to become active. This means that changes to the active configuration in the system that occur between Manager receiving and sending back the copy may be overwritten. For example this may affect changes made by users through their phone or voicemail mailbox after the copy of the configuration is received by Manager.

Manager is part of the IP Office Admin suite of programs. It is important to note that the software level of IP Office Manager application is 2 higher than the software level of the Essential Edition - PARTNER Version system core software with which it is released. For example IP Office Manager 8.0 is released with IP Office 6.0 core software.

When IP Office Manager is used with Essential Edition - PARTNER® Version, the PC running Manager is connected directly to the IP Office control unit being installed or updated. IP Office Manager detects that a PARTNER® Version is present and automatically starts in its Simplified mode designed to manage Essential Edition - PARTNER Version.

3.2 Getting Started

This section describes tasks that must be planned and executed before commencing installation of Essential Edition - PARTNER Version.

3.2.1 Unpacking

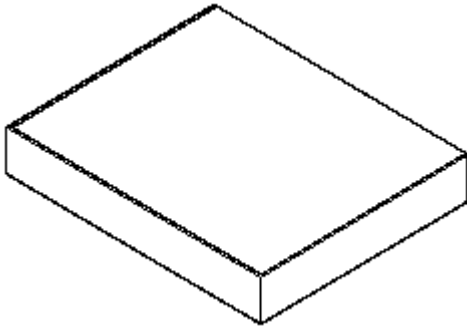

Objective - To check that the correct equipment has been supplied and that no damage has occurred during transit.

Use the following procedure when unpacking any equipment supplied by Avaya or an Avaya reseller or distributor.



Information Required

- Equipment Checklist.
Draw up an installation checklist of the parts and equipment expected.



Procedure

- Check for Package Damage.
Before unpacking any equipment, check for any signs of damage that may have occurred during transit. If any damage exists bring it to the attention of the carrier.
- Check the Correct Parts Have Been Delivered.
Check all cartons against the packing slip and ensure that you have the correct items. Report any errors or omissions to the equipment supplier.
- Retain All Packaging and Documentation.
While unpacking the equipment, retain all the packaging material. Fault returns are accepted only if repackaged in the original packaging. If performing a staged installation, the original packaging will also assist when repacking equipment to be moved to the final install site.
- Ensure that Anti-Static Protection Measures are Observed.
Ensure that anti-static protection measures are observed at all times when handling equipment with exposed electrical circuit boards.
- Check All Parts.
Visually inspect each item and check that all the necessary documentation and accessory items have been included. Report any errors or omissions to the dealer who supplied the equipment.
- Check All Documentation.
Ensure that you read and retain any documentation included with the equipment.

3.2.2 Environmental Requirements

Before you begin the physical installation of the system, you must check that all environmental factors are within the acceptable ranges. The planned location must meet the following requirements. If installing into a rack system, these are requirements for within the rack:

- Temperature: 0°C to 40°C / 32°F to 104°F.
- Humidity: 10% to 95% non-condensing.
- Check there are no flammable materials in the area.
- Check there is no possibility of flooding.
- Check that any other machinery or equipment that needs to be moved, is moved first.
- Check that it is not an excessively dusty atmosphere.
- Check that the area is unlikely to suffer rapid changes in temperature and humidity.
- Check for the proximity of strong magnetic fields, sources of radio frequency and other electrical interference.
- Check there are no corrosive chemicals or gasses.
- Check there is no excessive vibration or potential of excessive vibration, especially of any mounting surface.
- Check that where telephones are installed in another building, that the appropriate protectors and protective grounds are fitted.
- Check there is suitable lighting for installation, system programming and future maintenance.
- Check that there is sufficient working space for installation and future maintenance.
- Ensure that likely activities near the system will not cause any problems, e.g. access to and maintenance of any other equipment in the area.
- Where ventilation holes are present on any of the Essential Edition - PARTNER Version units, those holes should not be covered or blocked.
- The surface must be flat horizontal for free-standing or rack mounted installations.

Wall Mounting

In addition to the requirements above, the following are applicable to Essential Edition - PARTNER Version units that support wall mounting.

1. Units must only be mounted onto permanent wall surfaces.
2. The surface must be vertical and flat.
3. Orientation of the unit must be as shown in the section on [IP Office 500 Wall Mounting](#).
4. The appropriate Avaya [wall mounting](#) kits must be used.

IMPORTANT SAFETY INSTRUCTIONS

When using your telephone equipment, basic safety precautions should always be followed to reduce the risk of fire, electric shock and injury to persons, including the following:

1. Do not use this product near water, for example, near a bath tub, wash bowl, kitchen sink or laundry tub, in a wet basement or near a swimming pool.
2. Avoid using a telephone (other than a cordless type) during an electrical storm. There may be a remote risk of electric shock from lightning.
3. Do not use the telephone to report a gas leak in the vicinity of the leak.
4. Use only the power cord and batteries indicated in this manual. Do not dispose of batteries in a fire. They may explode. Check with local codes for possible special disposal instructions.

3.2.3 Read the Documentation

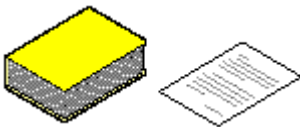

Ensure that you have read this manual in full before starting installation. Also include the installation documentation for any other equipment and applications being installed as part of the Essential Edition - PARTNER Version system.

-  IP Office Technical Bulletins

Ensure that you have obtained and read the IP Office Technical Bulletin relating to the IP Office software release which you intend to install on the Essential Edition - PARTNER Version. This bulletin will contain important information that may not have been included in this manual. IP Office Technical Bulletins are available from the web sites listed below.

Other IP Office Installation Manuals

The following components of IP Office are outside the range of a basic IP Office installation. They are covered by separate installation and configuration documentation. If those components are to be part of the Essential Edition - PARTNER Version system installation, that documentation should be obtained, read and understood prior to the installation.

Information Web Sites

IP Office documentation is available from the following web sites.

- Avaya Support - <http://support.avaya.com>
Contains documentation and other support materials for Avaya products including IP Office. Copies of the IP Office CD images are available from this site and updated core software .bin files.
- Avaya IP Office Knowledge Base - <http://marketingtools.avaya.com/knowledgebase>
Access to an on-line regularly updated version of the IP Office Knowledge Base. Currently this link is only available to Avaya Business Partners while running an ARA account (Avaya Remote Access) connection.

3.2.4 Space Requirements

IP Office 500v2 control unit and modules are designed to be installed either in a free-standing stack or into a 19" rack system. Rack installation requires a [rack mounting kit](#) for each control unit and expansion module.

Cable Clearance

Clearance must be provided at the front and rear of all modules for cable access, connections and insertion/removal of the SD card.

- Allow a minimum clearance of 90mm (3.5 inches).
- Additional Clearance
Care should be taken to ensure that the positioning of the modules does not interrupt air flow and other factors that may affect [environmental requirements](#). This is especially important on IP Office 500 control units which have ventilation slots at the side.
- Cable Access
Power cords must not be attached to the building surface or run through walls, ceilings, floors and similar openings. Installation measures must be taken to prevent physical damage to the power supply cord, including proper routing of the power supply cord and provision of a socket outlet near the fixed equipment or positioning of the equipment near a socket outlet.

When wall mounted, a clearance of 500mm is required on all sides. The ventilation slots on the rear and sides should not be covered or blocked.

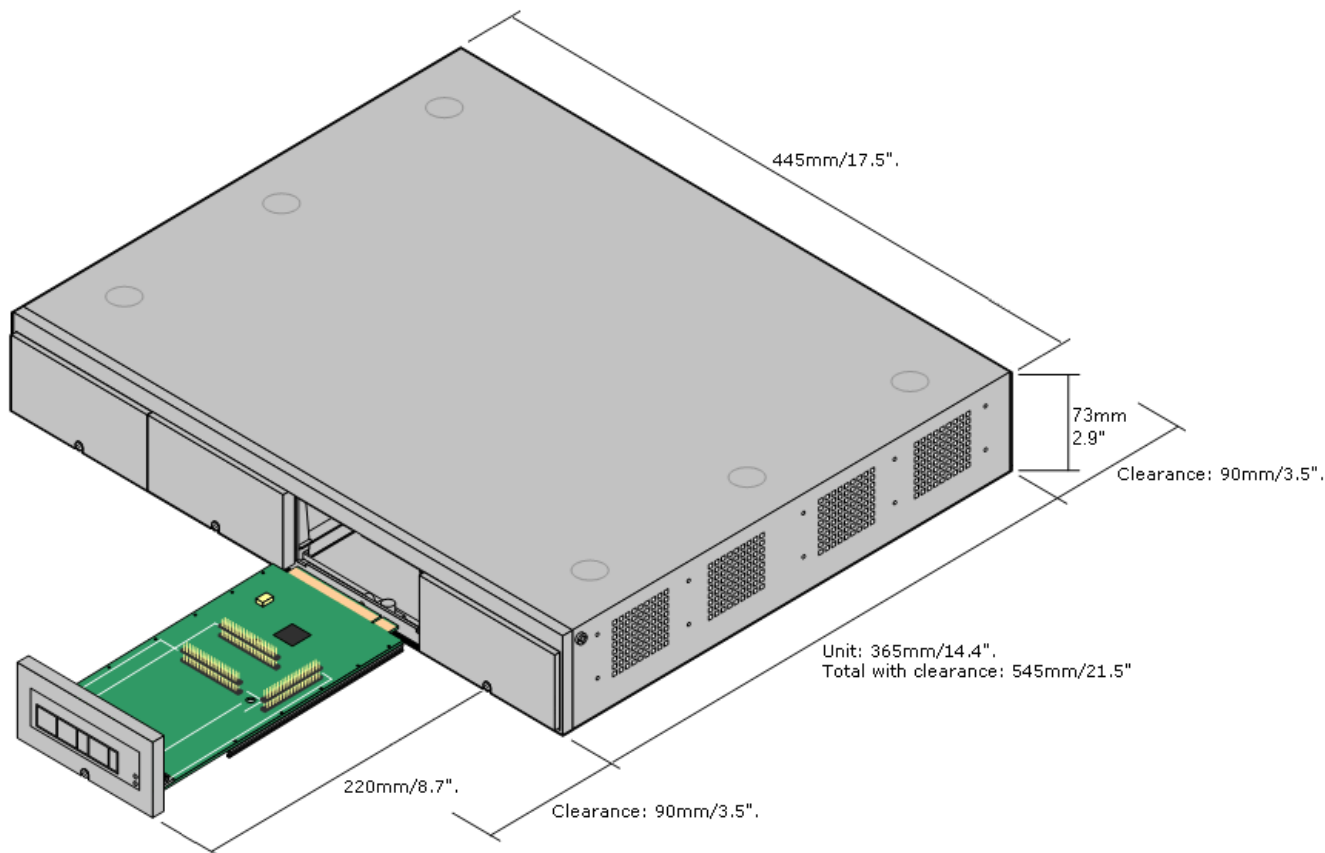

3.2.5 Tools and Parts Required

This section outlines the tools and miscellaneous parts likely to be required during the installation and setup of an Essential Edition - PARTNER Version system. Other tools may also be required.



Tools Required

1. Phillips No. 1 screwdriver for removal of module covers.
2. Cutter for cable ties.
3. Phillips No. 4 screwdriver.
4. Flat blade screwdriver, medium size
5. Wrist-strap for anti-static grounding or similar.
6. PC running Windows XP/2003.
During the Staging [Installation](#) later in this manual, we recommend that you use a Laptop PC with IP Office Manager Essential Edition - PARTNER Version installed using a directly connected LAN cable. This will enable you to make any changes to the basic configuration, system configuration, and set up user lists.
7. Indelible marker for cable labeling.



Parts Required

1. Cable ties.
2. Cabling labels.
3. Technical Bulletins
Each Essential Edition - PARTNER Version software release is normally accompanied by a Technical Bulletin detailing special installation requirements, known issues, etc. Various software releases and their associated Technical Bulletins can also be obtained from <http://support.avaya.com>.

3.2.6 Cabling and Cables

The Essential Edition - PARTNER Version system is designed primarily for use within an RJ45 structured cabling system using CAT3 unshielded twisted-pair (UTP) cabling and RJ45 sockets.

A structured cabling system is one where cables are run from a central RJ45 patch panel in the communications/data room to individual RJ45 sockets at user's desk. All wires in each cable between the patch panel and the desk socket are connected straight through. This arrangement allows devices connected at the patch panel to be swapped to match the type of device that needs to be connected at the user socket. For example, making one user socket a phone port and another user socket a computer LAN port, without requiring any rewiring of the cables in between.

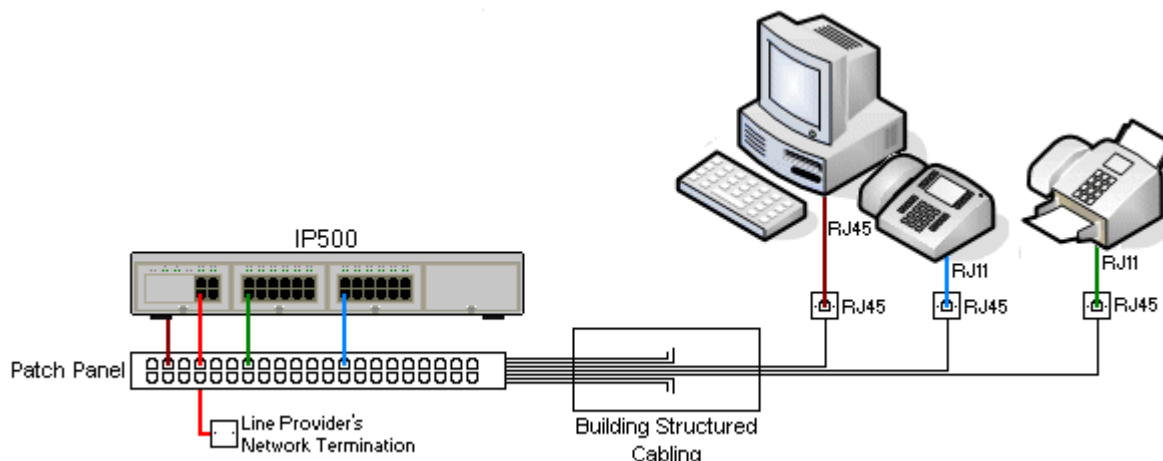

- Traditional IDC Punchdown Wiring Installations
Where necessary, the far end RJ45 plug can be stripped from IP Office cables and wired into traditional wiring systems using punch-block connectors. This type of installation should be performed by an experienced wiring technician.
- Trunk Connections
The majority of IP Office trunk ports use RJ45 connectors for acceptance of an RJ45-to-RJ45 cable. However, connection at the line providers end may require use of a different plug type in order to match the line providers equipment.
- RJ11 Phone Connectors
Many phones use RJ11 sockets and are supplied with RJ11-to-RJ11 cables. RJ11 plugs can be inserted into RJ45 sockets and in many case the connection will work. However this is not recommended or supported as the connection lock is not truly positive and may become disconnected. An RJ45-to-RJ11 cable is available for these connections.

Standard IP Office Cables

The following are Avaya standard cables available for use with IP Office systems. The maximum length is applicable if the standard Avaya cable is replaced with an alternative cable.

Cable	Description	Part number	Standard Length	Maximum Length
9-Way DTE Cable	Connects to control unit RS232 DTE port. 9-Way D-type plug to 9-way D-type socket.	–	2m/6'6"	2m/6'6"
Structured Cabling DS Line Cable	Connects from RJ45 sockets to RJ11 socketed DS and analog phones.	700047871	4m/13'2"	See table below.
PRI Trunk Cable	Connects PRI trunk ports to the line providers network termination point. RJ45 to RJ45. Red.	700213440	3m/9'10"	–
Expansion Interconnect Cable	Connects the control unit to expansion modules (except WAN3 modules). RJ45 to RJ45. Blue.	700213457	1m/3'3"	1m/3'3"
LAN Cable	Connects from IP Office LAN ports to IP devices. RJ45 to RJ45. Grey.	700213481	3m/9'10"	100m/328'

The table below details the maximum total cable distances for DS and analog extensions using different cable types.



Telephone	Unshielded Twisted-Pair (UTP) - 50nf/Km			CW1308
	AWG22 (0.65mm)	AWG24 (0.5mm)	AWG26 (0.4mm)	
1400 Series	1000m/3280'	1000m/3280'	400m/1310'	400m/1310'
ETR	1000m/3280'	1000m/3280'	400m/1310'	–
Analog Phones	1000m/3280'	1000m/ 3280'	400m/1640'	800m/2620'

3.2.7 Grounding

Use of ground connections reduces the likelihood of problems in most telephony and data systems. This is especially important in buildings where multiple items of equipment are interconnected using long cable runs, for example phone and data networks.

All IP Office control units and external expansion modules must be connected to a functional ground. In some cases, such as ground start trunks, in addition to being a protective measure this is a functional requirement for the equipment to operate. In other cases it may be a locale regulatory requirement and or a necessary protective step, for example areas of high lightning risk.

-  **WARNING**
 During installation do not assume that ground points are correctly connected to ground. Test ground points before relying on them to ground connected equipment.

The ground point on IP Office control units and external expansion modules are marked with a  or  symbol. Ground connections to these points should use a 14 AWG solid wire with either a green sleeve for a functional ground or green and yellow sleeve for a protective ground.

- Additional protective equipment
 In addition to grounding, additional protective equipment will be required in the following situations. Refer to "[Out of Building Telephone Installations](#)".
 - On any Digital Station or Phones external expansion module connected to an extension located in another building.

3.2.8 Rack Mounting

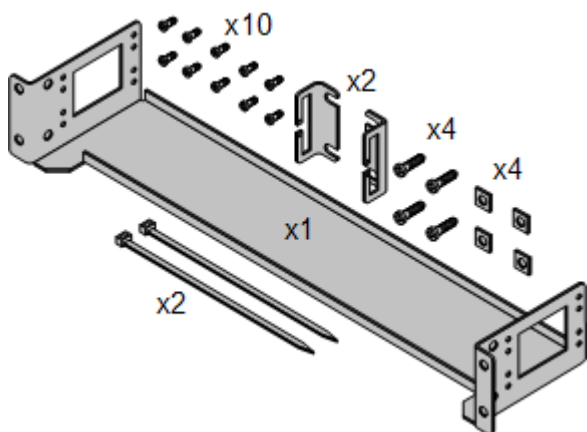

The IP Office 500v2 control unit and IP Office 500 external expansion units can be rack mounted if required into 19-inch rack systems. This requires an IP Office 500 Rack Mounting Kit (SAP 700429202) for each unit.

The kit includes:

- A rack mounting bracket and screws for attachment of the bracket to the unit
- Nuts and bolts for rack attachment.
- Brackets and cable ties for cable tidying.

As indicated in the diagram following, the rack mounting bracket can be used in several positions on the unit.

Environmental Requirements

In addition to the existing [environmental requirements](#) for an Essential Edition - PARTNER Version system, the following additional factors must be considered when rack mounting a unit:

1. Rack Positioning - Ensure compliance with the rack manufacturers safety instructions. For example check that the rack legs have been lowered and fixing brackets have been used to stop toppling.
2. Elevated Operating Ambient - If installed in a closed or multi-unit rack assembly, the operating ambient temperature of the rack environment may be greater than room ambient. Therefore, consideration should be given to installing the equipment in an environment compatible with the maximum ambient temperature (T_{ma}) specified by the manufacturer.
 - Operating Temperature: 0°C (32°F) to 40°C (104°F).
 - Operating Humidity: 10% to 95% non-condensing.
3. Reduced Air Flow - Installation of the equipment in a rack should be such that the amount of air flow required for safe operation of the equipment is not compromised. Proper ventilation must be maintained. The side ventilation slots on the IP Office 500 control unit should not be covered or blocked.
4. Mechanical Loading - Mounting of the equipment in the rack should be such that a hazardous condition is not achieved due to uneven mechanical loading.
5. Circuit Overloading - Consideration should be given to the connection of the equipment to the supply circuit and the effect that overloading of the circuits might have on over-current protection and supply wiring. Appropriate consideration of equipment nameplate ratings should be used when addressing this concern.
6. Reliable Earthing - Reliable earthing of rack-mounted equipment should be maintained. Particular attention should be given to supply connections other than direct connections to the branch circuit (e.g. use of power strips).
7. ⚠ Only the screws (M3 x 6mm) provided with the mounting kit should used to attach the brackets to the control unit.

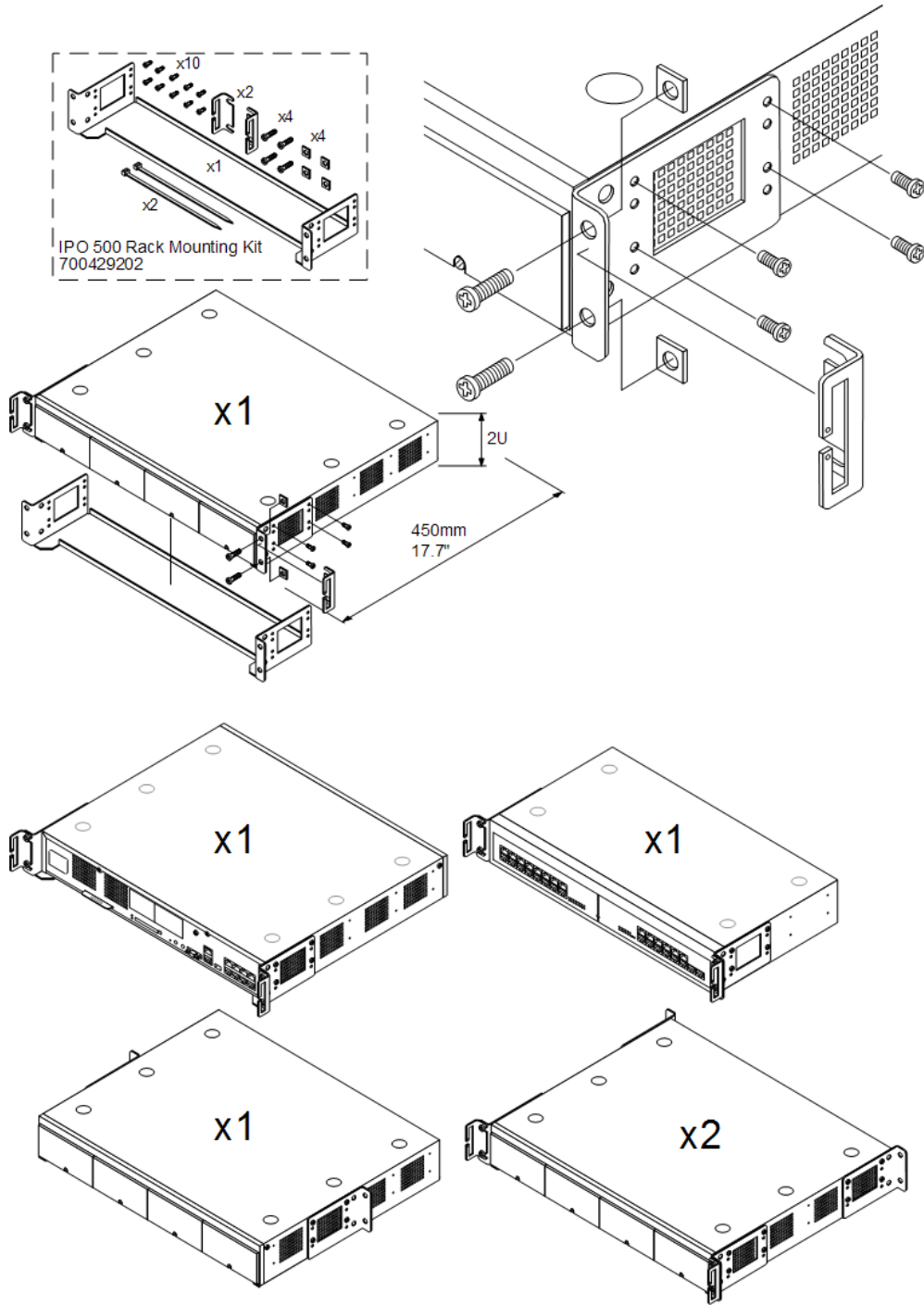

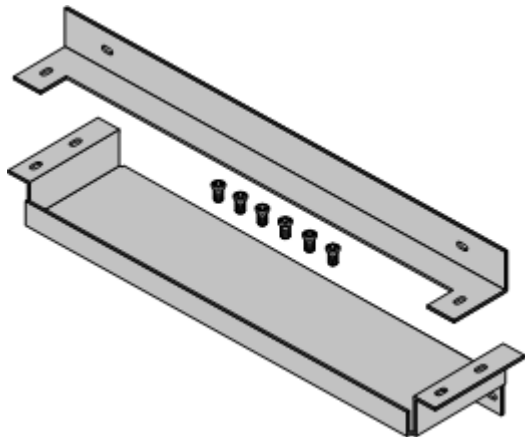

3.2.9 Wall Mounting



The IP Office 500v2 control unit can be wall mounted. This requires an IP Office 500 Wall Mounting Kit (SAP 700430150) plus additional 4.5mm fixtures and fittings suitable for the wall type. The wall mounting kit includes two brackets, one top and one bottom.

Environmental Requirements
 In addition to the existing [environmental requirements](#) for an Essential Edition - PARTNER Version system, the following additional requirements apply when wall mounting a unit:

-  The wall surface must be vertical, flat and vibration free.
-  A minimum clearance of 500mm (19.7 inches) is required on all sides.

- ⚠ The unit must be orientated as shown when mounted. That is with the base card slots facing right when viewed from in front of the unit.
- ⚠ The brackets must be used as shown, with the deeper tray-like bracket used at the bottom of the wall mounted control unit.
- ⚠ Only the screws (M3 x 6mm) provided with the mounting kit should used to attach the brackets to the control unit.

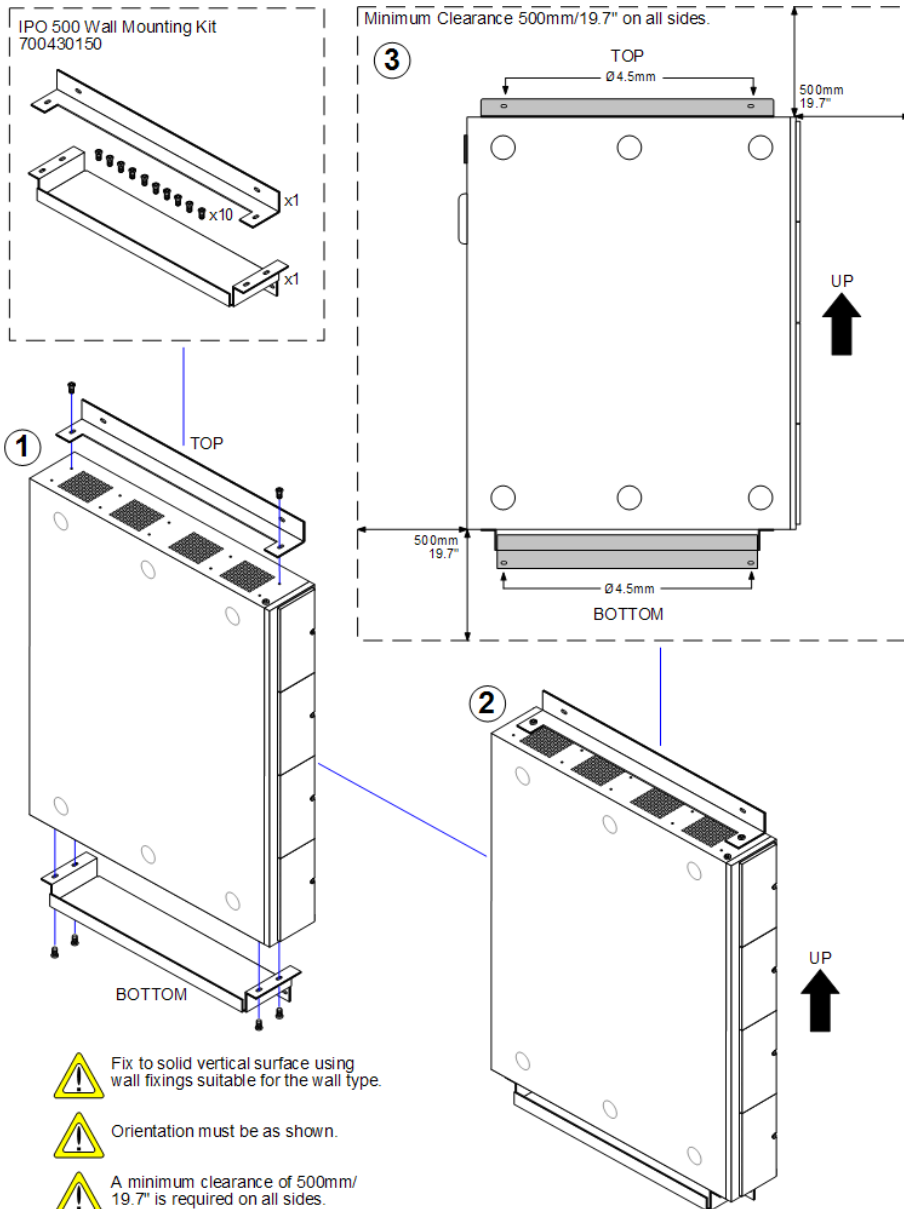

- ⚠ The brackets must be used as shown, with the deeper tray-like bracket used at the bottom of the wall mounted control unit.
- ⚠ Only the screws (M3 x 6mm) provided with the mounting kit should used to attach the brackets to the control unit.

3.3 Install Overview

Essential Edition - PARTNER Version is an *out of the box* installation and is meant to work correctly when it is switched on, without requiring any setting up or pre configuration. The efficiency of this automatic procedure is simplified and guaranteed by following a few basic rules in connecting up cable groups and populating the card slots of the control unit as follows:

- Insert [base cards](#) working from left to right and do not leave unoccupied slots between cards.

- Apply simple housekeeping rules to cables by tying them in associated and clearly labeled bundles.
- Route cables carefully so that they do not intrude the working area or create a hazard

The basic installation procedure described in the following sections is as follows:

1. Check out the telephone [connection](#) system.
2. Equip the control unit with base cards, pre fitted where necessary with daughter cards.
3. Insert the supplied [SD](#) card.
4. Connect a laptop PC that has IP Office Manager 6.0 or above, to the control unit ([Item 6 in tools](#)).
5. Switch ON the control unit. Essential Edition - PARTNER Version automatically "[sniffs](#)" the connected system and contacts the laptop. To do this, The control unit initializing firmware sends its configuration .ini files to the SD card where they are checked against the current versions on the card. The control unit performs a [boot up](#) sequence that varies according to what is detected during the discovery phase.
6. Switch ON the laptop. [Office Manager](#) on the PC displays the administration home screen which identifies basic system components and system settings.
7. Plug in connection infrastructure and telephone handsets to control unit.
8. Use Manager to complete system configuration.

 The install procedure detail is elaborated in the following sections

3.4 Card Installation

This section describes in order, the procedures to equip an IP 500v2 control unit for use with Essential Edition - PARTNER Version.



Warnings

- Correct anti-static protection steps should be taken before handling circuit boards.
- During this process power to the IP Office control unit must be switched off and disconnected.

IP500 Trunk Daughter Card Preparation

IP500 trunk daughter cards should be fitted to any base card requiring them.

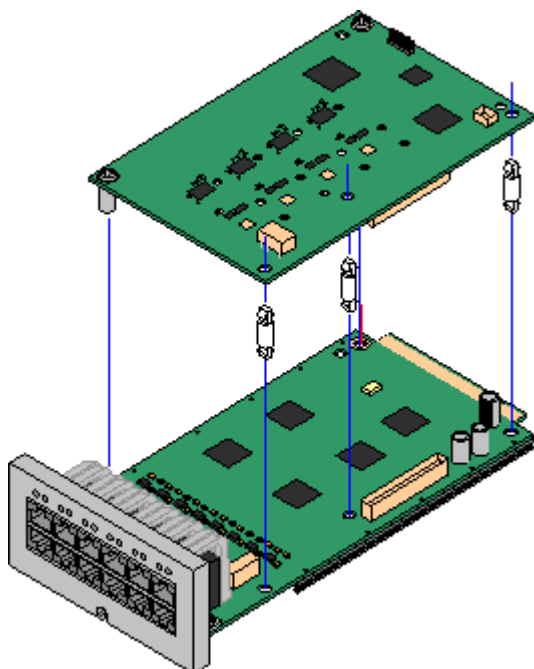

Parts and Equipment Required

1. IP500 base cards
2. IP500 Trunk cards if required
3. Stand Off Pillars, these are supplied with the trunk daughter card.



Tools Required.

1. 5mm Flat-blade screwdriver.
2. Anti-static wrist strap and ground point.



Procedure:

1. Check that correct cards have been supplied.
2. Ensure that you are wearing an anti-static wrist strap connected to a suitable ground point.
3. On the base card identify the position of 3 holes for the plastic pillars for the daughter card. These are along the same edge as the card connector.
4. Fit the stand off pillars to the base card.
5. If there is a clip-on metal shield over the connector block on the base card, remove it.
6. Using minimal force and checking that the pins are correctly located, push the daughter trunk card down onto its connector block and the stand off pillars.
7. Check that the card connector has snapped into position.

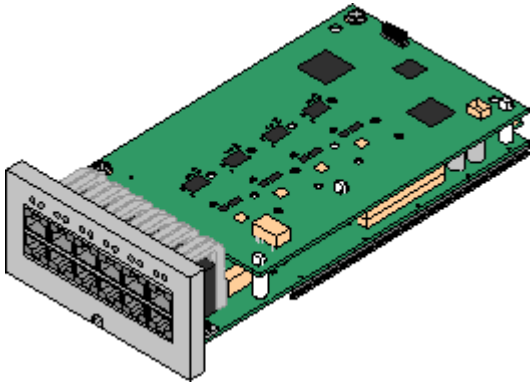

8. Using the washers and screws provided, secure the metal stand off pillars to the base card.
9. A set of labels are supplied with the trunk daughter card. Fit the appropriate label to the front of the base card.
10. Prepare any other base cards. Then proceed to inserting the base cards.

Base Card Installation

Having prepared each base card by adding any daughter cards required, the base cards can be inserted into the control unit.

Warnings

- Correct anti-static protection steps should be taken before handling circuit boards.
- During this process power to the IP Office control unit must be switched off and disconnected.

Tools Required.

- 5mm Flat-blade screwdriver.
- Anti-static wrist strap and ground point.

Procedure:

1. Using a flat-bladed screwdriver, remove the covers from the slots on the front of the control unit. This cover is no longer required but should be retained until installation has been completed.

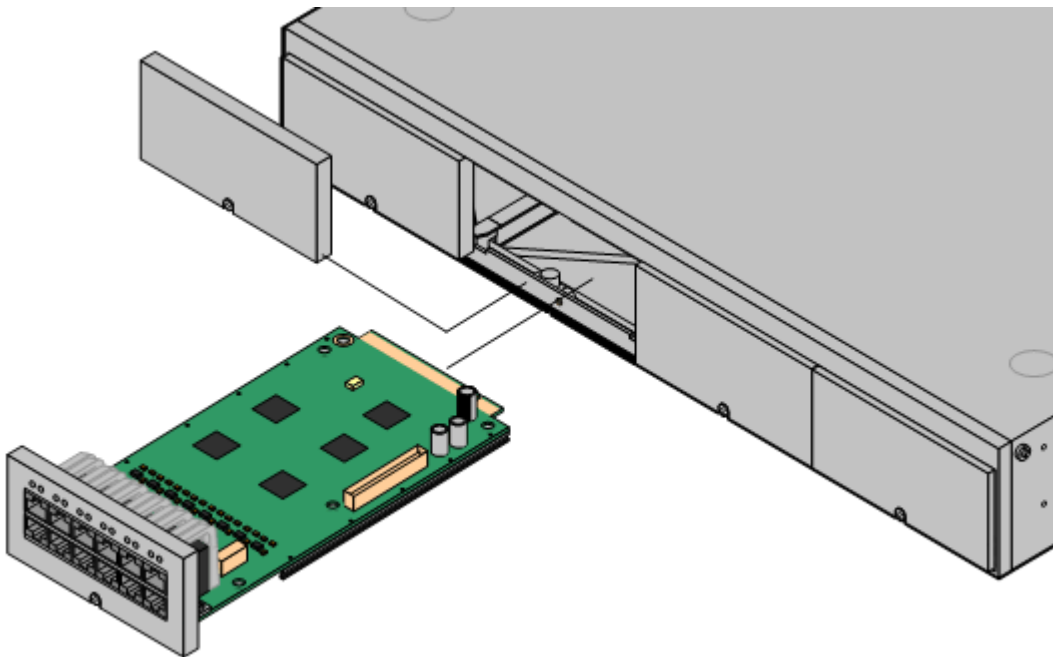

2. Allowing the card to rest against the bottom of the slot, begin sliding it into the control unit. When half inserted, check that the card rails have engaged with the slot edges by trying to gently rotate it. If the card does rotate remove it and begin inserting it again.
3. The card should slide in freely until almost fully inserted. At this point apply pressure at the base of the front of the card to complete insertion into its connector block.
4. Using a flat-bladed screwdriver secure the base card.

General Notes

- Cards can be fitted in any order into any available slots. The only exception is the IP500 4-Port Expansion card which can only be installed in right hand slot 4.
- It is recommended that cards are fitted from left to right.
- There are restrictions to the number of supported cards of some types. When such a limit is exceeded, the right-most card of that type will not function.
- Ensure that you use the labels supplied to identify the card fitted into the control unit.

3.5 Start-up

- !** Do not begin this procedure until all cards are [installed](#) in the control unit. During installation it is recommended that the control unit is started without it being connected to any other unit. This ensures that the Essential Edition - PARTNER Version defaults to a known set of IP address settings.

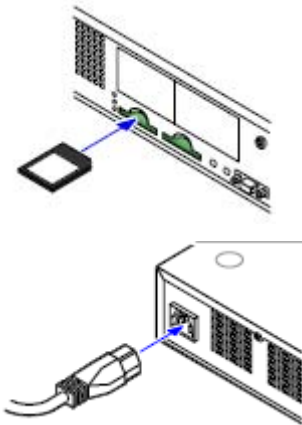

With power off, insert the SD card into the first rear panel slot (System SD) of the control unit.

Apply power to the control unit.

Check that the orange LED lamp on the IP Office LAN port is on. The green LED may also be flickering as it indicates traffic across the LAN connection

As the control unit goes through its [start-up cycle](#), make the following checks:

1. When power to the control unit is switched on, the normal sequence for the CPU LED is as follows.
 - a) The CPU LED changes to green
 - b) Steady Red for 3 seconds
 - c) Off for 10 seconds
 - d) Flashing alternate red/green for 4 seconds.
 - e) The LED should be steady green following successful start up. Note that the IP Office 500 cards on the front of the control unit may still be going through their own start up process.
- Flashing RED
A flashing red CPU LED at this stage indicates an error. The most likely cause is a missing or loose SD card.
2. The System SD LED changes to green
3. The LAN connection LED flashes and then settles to steady green
4. Card module front lamps light randomly but after approximately 30 second the No.1 lamps flash together once every 5 seconds
5. Connect the laptop via an R45 lead to the LAN socket on the control unit rear panel.
6. Start up Manager on the installation laptop.



5. The splash screen displays briefly as Manager application starts.

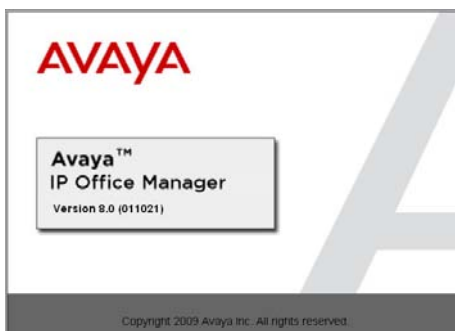

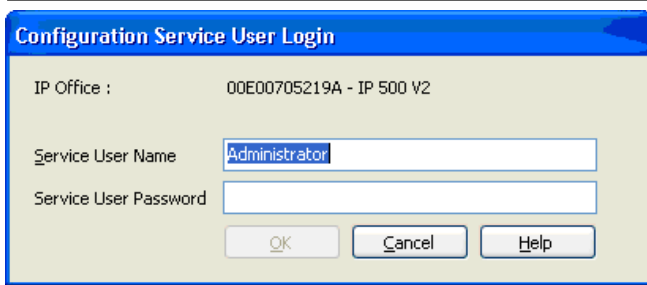

8. The login dialog is displayed. Default Service User password is *Administrator*.

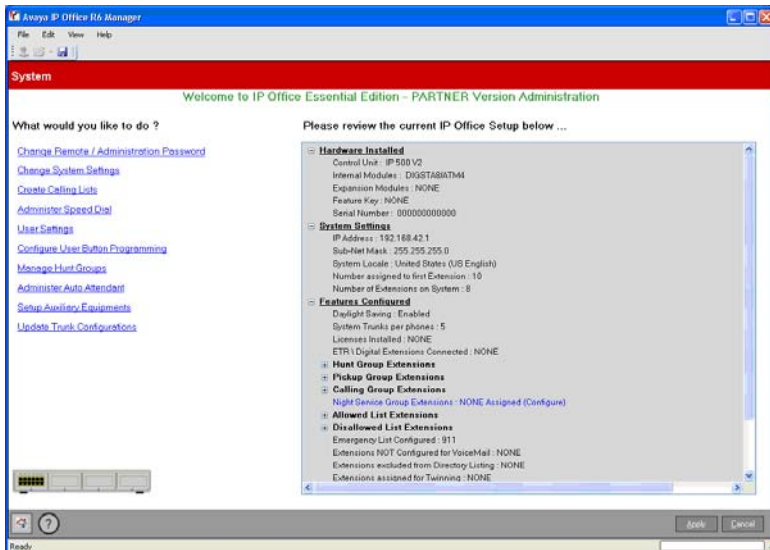

9. The Administrator Home Page is displayed.

This view confirms that installation of the Essential Edition - PARTNER® Version system has been successful

3.6 Connections

If the site already has a patch panel for all outside lines and extensions, you should be able to use the existing wiring to install the system hardware and connect telephones to the system yourself.

During control unit startup

- Extensions and Users
A user is automatically created for each physical extension port detected in the system. Users are assigned extension numbers starting from 10. User names take the form Extn10, Extn11,
- Hunt Group
A single hunt group 1 called Main is created and the first 10 users are placed into that hunt group as members.

Testing the modules

Test the control unit base card modules by doing the following:

- a. Plug a system telephone into the first port on each module.
- b. Press the line button on the telephone for each outside line and listen for a dial tone.

Installing Telephones

After you have installed the IP Office 500v2 control unit and have connected the line and extension cords, you are ready to install the telephones. Installing the telephones includes assembling, connecting and configuring, the telephone. As desired, you also can connect an Intercom Autodialer to certain telephones

Assembling PARTNER® Version Telephones

All Essential Edition - PARTNER Version telephones are shipped with a stand for either desk-mounting or wall-mounting the telephone. For other telephones, see the instructions that are provided with the telephone.

Gather the line and extension cords hanging from the control unit and twist-tie or wire-wrap them.

Connecting handsets

1. For telephone systems that are based on a patch (intermediate) connection system:
2. Connect line cords to the line jacks on the modules.
3. Connect the free end of each line cord to the appropriate telephone network interface jack
4. Fill each module before moving to the next module to the right

 As each handset is connected and configured any necessary software it contains is automatically checked and updated as necessary.

3.7 Final Actions

You may be required to compile calling lists, build groups and allocate permissions etc. before leaving the customer premises. This depends on arrangements made between your local office and the customer. If required, use Manager to create any lists. Changes to the basic Essential Edition - PARTNER® Version configuration, setting up trunks, adding licenses etc. are detailed in the Avaya IP Office Essential Edition - PARTNER Version Administrator Tool User Guide identified in the [Introduction](#).

 As you use Manager to make changes to the Essential Edition - PARTNER Version setup, you are prompted to save or discard changes you have made before leaving any administration window to go on to another task. However, you should remember that you are accumulating these changes in a COPY of the control unit configuration file which must be saved back to the SD card before changes are effective. Similarly, system changes such as plugging in handsets during this time are recognized by the Essential Edition - PARTNER Version system control unit but are undetected by Manager which is working with a copy of the configuration file. Avaya recommend that whilst using Manager you save the configuration file at frequent intervals to ensure the working copy and Manager copy of the configuration file remain as compatible as possible.

 Do not leave the Manager application open for long periods and particularly when it is not being used.

Check system operation and gather all packing materials for disposal.

If appropriate, obtain sign-off signature.

Chapter 4.

System Component Details

4. System Component Details

This section contains detailed descriptions of each of the component parts of Essential Edition - PARTNER® Version.

4.1 Control Unit

The base item of the IP Office system is the system server or control unit. It stores the system configuration and controls system operation. The Essential Edition - PARTNER Version system uses the IP Office 500v2 model R6.0 control unit.

A control unit can be customized by adding various internal cards such as trunk cards. An external expansion module can be also be connected.

The slots are numbered 1 to 4 from left to right. They can be used in any order. However if the capacity for a particular type of card is exceeded, the card in the rightmost slot will be disabled. The unit must not be used with uncovered slots.

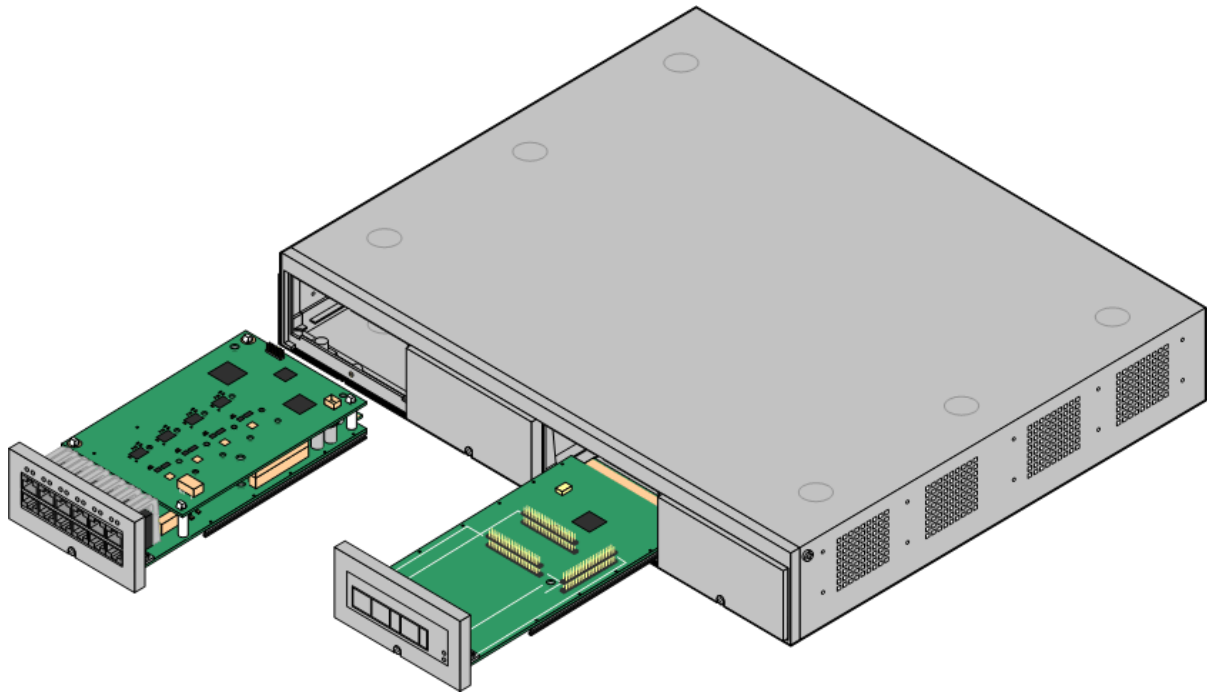

Feature	Capacity
Maximum Extensions	Up to 48 extension ports of which there may be a maximum of 18 ETR ports.
Conference Parties	10 as standard with no silence suppression.
Trunks Cards	Any combination of IP Office 500trunk daughter cards and up to 2 IP400 trunk cards.
Voicemail Channels	Maximum 2, expandable to 6 subject to available licenses.
Software Level	<ul style="list-style-type: none"> • IP Office core software level 6.0 minimum. • Bin file = ip500v2.bin.
Power Supply	Internal power supply unit.
Mounting	Free-standing, rack mounted (requires IP Office 500Rack Mounting Kit) or wall mounted (requires IP Office 500Wall Mounting Kit).
Dimensions	Width: 445mm/17.5". Depth: 365mm/14.4". Height: 73mm/2.9"/2U. Clearance: 90mm minimum all sides, 220mm at front. 500mm all side when wall mounted.
Memory	Maximum configuration file size: 2048KB.

4.1.1 Rear Connections

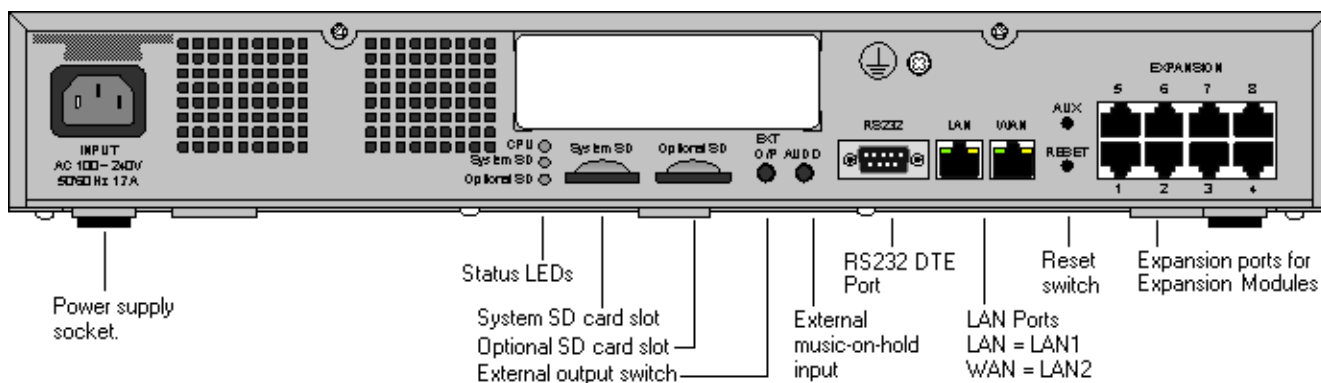

Only Port 1 of the extreme right hand expansion ports should be used.

Ports	Description
AUDIO	3.5mm Stereo jack socket. Used for external music on hold source input.
AUX	If pressed during a restart of the control unit, the control unit skip booting from the <code>/primary</code> folder on the System SD card. If pressed for between 5 and 10 seconds when a system is running, the control unit will shutdown for 10 minutes.
CPU	Indicates the status of the control unit. <ul style="list-style-type: none"> • Alternate red/green = Starting up. • Green on = Okay. • Red on = No software. • Flashing Red = Error/Shutdown.
EXPANSION	RJ45 socket. Used for direct connection to external expansion modules using the Expansion Interconnect cable supplied with the expansion module. Only one expansion jack is supported by Essential Edition - PARTNER Version Only Port 1 of the extreme right hand expansion ports should be used.
EXT O/P	3.5mm Stereo jack socket. Used for switching external relay systems such as door entry controls. The port contains two independent switches controlled by the IP Office.
INPUT	AC power input port.
LAN	RJ45 socket. With the WAN port forms a managed layer 3 Ethernet switch. The ports are full-duplex 10/100Mbps auto-sensing, MDI crossover ports.
Optional SD	Used for the Optional SD card. The LED is used in the same way as for the System SD (<i>see below</i>).
RESET	This switch is used to restart the IP Office, optionally erasing the configuration and or the core software in the process. See table below.
RS232	9-Way D-Type socket. Used for system maintenance.
System SD	Used for the System SD card,. The LED is used as follows. <ul style="list-style-type: none"> • Off = Card shutdown. • Green on = Card present. • Green flashing = Card in use. • Orange steady = Reset imminent. • Red flashing = Card initializing or shutting down. • Red fast flashing = Card full • Red steady = Card failure/wrong type.
WAN	Not used in Essential Edition - PARTNER Version
	Used for connection of a function or protective ground . Use of a ground for all systems is recommended and for some locales may be a regulatory requirement.

Reset button.

Do not use the reset button except under supervision and instruction from technical support personnel.

Pressing the button while the control unit is starting up will pause the start up until the button is released. The effect of pressing the button during normal operation depends on how long the button is pressed and is indicated by the CPU LED.

Press Duration (seconds)	CPU LED	Action	Summary
0 to 5.	Off	None	None.

Press Duration (seconds)	CPU LED	Action	Summary
5 to 10.	Orange	Reboot When Free	Reboot when free with new incoming/outgoing call barring. A reboot using the reset button is recorded in the Audit Trail.
10 to 30.	Flashing orange	Erase Configuration/ Immediate Reboot	Erase the configuration, alarm log and audit trail. Immediate reboot without waiting for active calls to end.
30 to 40.	Red	Erase All.	Erase configuration, alarm log and core software.
Over 40.	Flashing green	None	None.

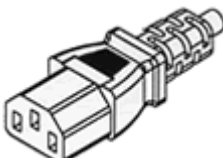
Name	Description	Country	Part number
IPO 500 V2 Base Unit	IP Office 500 V2 Base Unit		700476005
Avaya SD Memory Card	IPO System SD Card Partner® Version		700479728
IEC60320 C13 Earthed Power Cord 	NEMA5-15P	America	700289770
IP Office 500Rack Mounting Kit	IP Office 500Rack Mounting Kit		700429202
IP Office 500Wall Mounting Kit	IP Office 500Wall Mounting Kit		700430150
IP Office 500Blanking Plate Kit	IP Office 500Blanking Plate Kit		700429194

4.2 SD Card

The Avaya SD card exercises central control over the Essential Edition - PARTNER Version system and acts as the License authorization for the control unit. The SD card is inserted into the System SD slot on the rear of the control unit.

Except when necessary during maintenance, the System SD slot should contain an Avaya SD card at all times. The files on that card are used when the system is started and the Feature Key serial number, only present on Avaya cards, is used for the licensing of IP Office features.

- The control unit has two SD card slots labeled System SD and Optional SD.
- The system SD card is also used to store copies of core software binary files, configuration files and backups as well as the voice mail application and the system status application.
- Embedded voicemail on the SD card provides 2 channels by default but can be licensed for up to 6 channels total.
- Various commands within the Manager interface enables the SD card contents to be backed up, restored or copied. These actions can also be achieved via the handset; instructions to do this are provided in the system TUI guide.
- The additional SD card slot can be used to store occasional full copies of the System SD card. or as an additional memory card to or from which, files can be copied. Non-Avaya cards can be used for this as long as they conform to the standard below:

SDHC minimum 4GB FAT32 format (Single partition, SDHC, class2+, FAT32, SPI & SD bus).

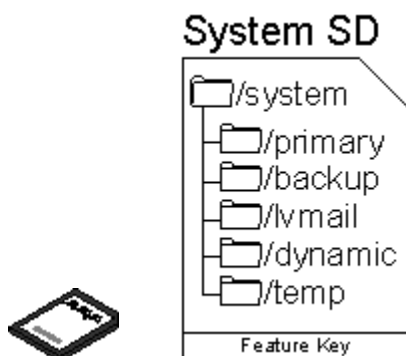

See also [SD Card Actions](#)

⚠ SD Card Removal

SD cards should never be removed while being used. Though the SD card slot LEDs indicate when data is being written to an SD card, lack of flashing LED is not a sufficient safeguard. The IP Office Manager provides methods to [shutdown and restart an individual card](#) or to [shutdown the](#) Essential Edition - PARTNER Version system in order to allow removal of an SD card. If the System SD card is removed, licensed features will continue operating for up to 2 hours.

4.3 Base Cards

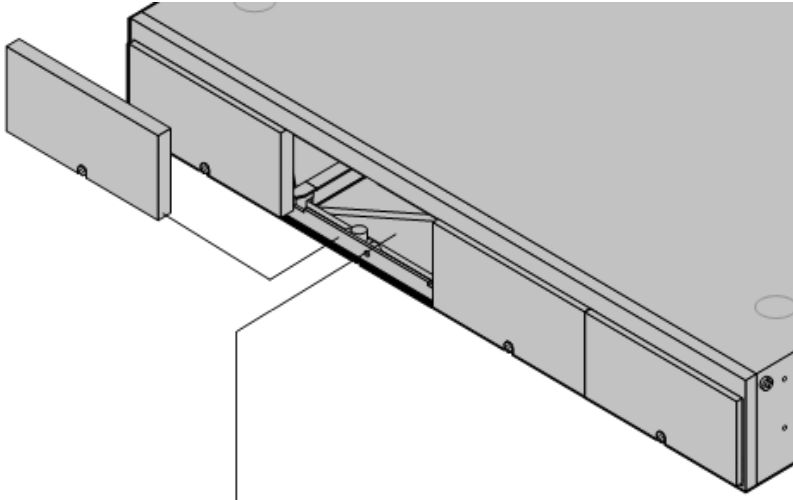

The IP Office 500v2 control unit has 4 slots to accommodate base cards. Each base card includes an integral front panel with ports for cable connections.

The slots are numbered 1 to 4 from left to right. Normally they can be used in any order, however if the capacity for a particular type of card is exceeded, the card in the highest slot will be disabled.

[IP Office 500 Analog Phone Base Card](#)

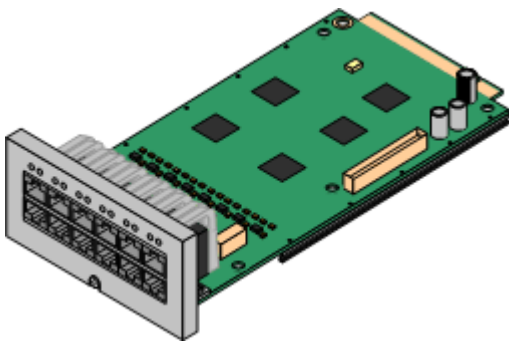

This card has 12 RJ45 ports. The card is available in two variants, providing 2 or 8 analog extension ports for the connection of analog phones. The card can be fitted with an IP Office 500 daughter card which then uses the additional 4 RJ45 ports for connections.

- This card accepts one IP Office 500 daughter card of any type supported by Essential Edition - PARTNER Version. See [Constraints](#).
- Maximum: 4 per control unit.
- When fitted with an IP Office 500 Analog Trunk daughter card, the Phone 8 base card supports 1 power failure extension to trunk (loop-start only) connection.
- The analog extension ports do not include a ringing capacitor. Where this is a requirement, connection should be via a Master socket containing ringing capacitors.

[IP Office 500 ATM Combination Card](#)

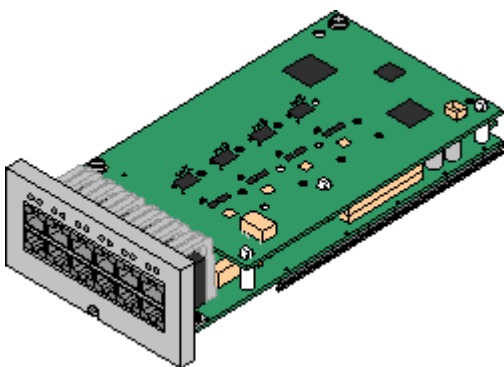

This card provides 6 digital station ports (1-6), 2 analog extension ports (7-8) and 4 analog trunk ports (9-12). The card also includes 10 VCM channels.

- This card has a pre-installed IP Office 500 ATM daughter card.
- Maximum: 2 combination cards per control unit.
- During power failure port 8 is connected to port 12.

[IP Office ETR-6 Base Card](#)

This card is only supported in an IP Office 500v2 control unit running in PARTNER® Version mode. It provides 6 ETR ports for connection of ETR phones. 2 Analog extension ports are also provided for emergency use only with an analog trunk card.

- The card can be fitted with an IP500 trunk daughter card which uses the base card ports for trunk connection.

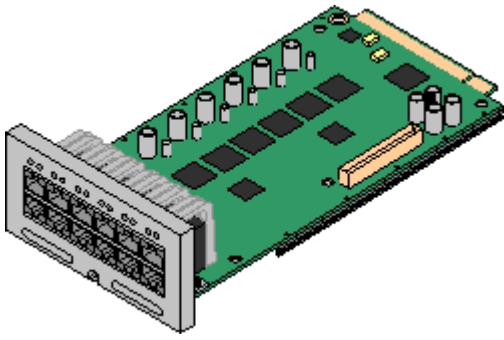

- Maximum: 3 per control unit.
- The analog phone ports do not include a ringing capacitor. Where this is a requirement, connection should be via a Master socket containing ringing capacitors.
- If fitted with an IP Office 500 Analog Trunk daughter card, during power failure phone ports 7 and 8 are connected to analog trunk port 12. However during normal operation analog phone ports 7 and 8 are not useable.

IP500 Digital Station Base Card

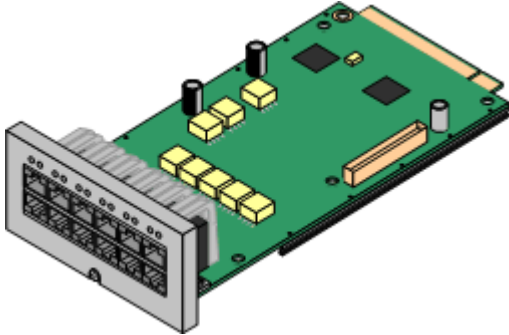

This card provides 8 DS (digital station) ports for the connection of Avaya digital phones other than IP phones.

- The card can be fitted with an IP Office 500 trunk daughter card which uses the base card ports for trunk connection.
- Maximum: 3 per control unit.
- 4400 Series phones (4406D, 4412D and 4424D) are not supported on this card. They are supported on an external expansion module.

4.3.1 Digital Station

This card is used to add digital station (DS) extension ports to the IP 500v2 control unit. It provides 8 RJ45 DS extension ports for use with Avaya digital phones not including IP phones. A further 4 RJ45 ports are provided for trunk connections when an IP500 trunk card is fitted to this card.

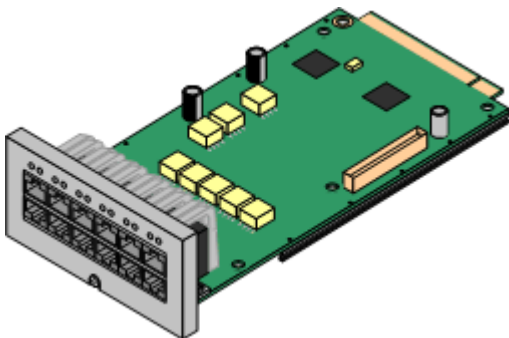

- Supports Provides 8 DS ports for [digital stations](#) supported
- Maximum per Control Unit: 3.
- IP500 Daughter Card Support: ✓ 1.

Port Type	Ports	Features	Port LEDs
Digit Station	1 to 8	Provides DS ports for digital stations (except 4406D, 4412D and 4424D).	<ul style="list-style-type: none"> • Green On - Phone detected. • LED1 is used for base card status: <ul style="list-style-type: none"> • Red On = Error • Red Slow Flash = Initializing. • Red Flash every 5 seconds = Card okay. • Red Fast Flash = System shutdown.
Optional Trunk Card Ports	9 to 12	The card can be fitted with one of the following trunk daughter cards. The trunk daughter card then uses ports 9 to 12 on the base card for its trunk connections. <ul style="list-style-type: none"> • IP500 Analog Trunk Card. 	LED use depends daughter card type fitted. <ul style="list-style-type: none"> • LED 9 is used for daughter card status. <ul style="list-style-type: none"> • Red On = Error • Red Slow Flash = Initializing. • Red Flash every 5 seconds = Card okay. • Red Fast Flash = System shutdown. <p>Analog Trunk Daughter Card</p>

		<ul style="list-style-type: none"> IP500 PRI Trunk Card. 	<ul style="list-style-type: none"> Green on: Card fitted. Green flashing: Trunk in use. <p>PRI Trunk Daughter Card</p> <ul style="list-style-type: none"> Off: No trunk present. Green on: Trunk present. Green flashing: Trunk in use. <ul style="list-style-type: none"> Red/Green Fast Flash (port 9) or Green Fast Flash (port 10): Alarm indication signal (AIS) from the trunk remote end. Red with Green Blink (port 9) or Green Blink (port 10): Port in loopback mode (set through IP Office System Monitor).
--	--	---	---

Name	Description	Part Number
I PO 500 Extn Card Dgtl Sta 8	IP Office 500 Extension Card Digital Station 8	700417330

4.3.2 Analog Phone

This card is used to add analog phone extension ports to the IP 500v2 control unit. It is available in two variants, providing either 2 or 8 analog extension ports.

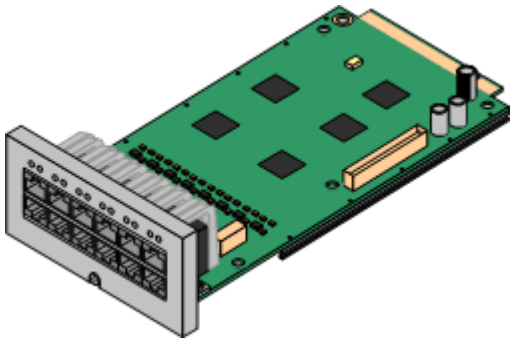

- Supports Provides either 8 or 2 [analog](#) phone ports depending on card variant.
- Maximum per control unit: 4.
- IP500 Daughter Card Support: ✔ 1.

Port Type	Ports	Features	Port LEDs
Analog Extension	1 to 8	<ul style="list-style-type: none"> Supports ICLID modes DTMFA, DTMFC, DTMFD, FSK and UK20. REN 2 (1 for external bell device). Off-Hook current: 25mA Ring Voltage: 40V. Intended for connection to two-wire analog phones, the ports do not include a ringing capacitor. For connection to 4-wire analog phones, connection should be via a master socket with ringing capacitors. If fitted with an analog trunk card, for the Phone 8, during power failure extension port 8 is connected to the analog trunk port 12. 	<p>No status LEDs are used for analog phone extensions.</p> <ul style="list-style-type: none"> LED1 is used for base card status: <ul style="list-style-type: none"> Red On = Error Red Slow Flash = Initializing. Red Flash every 5 seconds = Card okay. Red Fast Flash = System shutdown.

Optional Trunk Card Ports	9 to 12	<p>The card can be fitted with one of the following trunk daughter cards. The trunk daughter card then uses ports 9 to 12 on the base card for its trunk connections.</p> <ul style="list-style-type: none"> • IP500 Analog Trunk Card. • IP500 PRI Trunk Card. 	<p>LED use depends daughter card type fitted.</p> <ul style="list-style-type: none"> • LED 9 is used for daughter card status. <ul style="list-style-type: none"> • Red On = Error • Red Slow Flash = Initializing. <p>Analog Trunk Daughter Card</p> <ul style="list-style-type: none"> • Green on: Card fitted. • Green flashing: Trunk in use. <p>PRI Trunk Daughter Card</p> <ul style="list-style-type: none"> • Off: No trunk present. • Green on: Trunk present. • Green flashing: Trunk in use. <ul style="list-style-type: none"> • Red Flash every 5 seconds = Card okay. • Red Fast Flash = System shutdown. • Red/Green Fast Flash (port 9) or Green Fast Flash (port 10): Alarm indication signal (AIS) from the trunk remote end. • Red with Green Blink (port 9) or Green Blink (port 10): Port in loopback mode (set through IP Office System Monitor).
---------------------------	---------	---	---

Name	Description	Part Number
IPO 500 Extn Card Phone 2	IP Office 500 Extension Card Phone 2	700431778
IPO 500 Extn Card Phone 8	IP Office 500 Extension Card Phone 8	700417231

4.3.3 ETR6 Card

This card is used to add 6 ETR phone extension ports to the IP 500v2 control unit. This card is only supported by IP500 V2 systems running in Essential Edition - PARTNER Version mode.

It also includes 2 analog extension ports which are for emergency use only when the card is fitted with an analog trunk daughter card. A further 4 RJ45 ports (9 to 12) are provided for trunk connections when an IP500 trunk daughter card is fitted to this card.

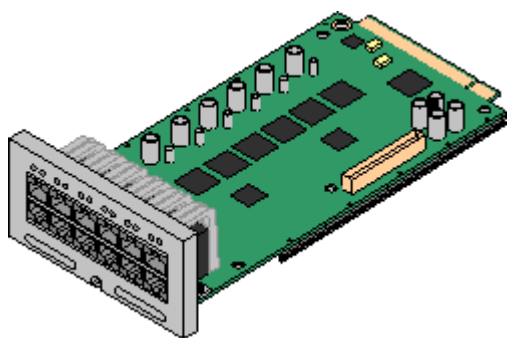

- Supports ETR and analog phones.
- Maximum per IP500 Control Unit: 3.
- IP500 Daughter Card Support: ✓ 1. The IP500 BRI trunk daughter card is not supported.

Port Type	Ports	Features	Port LEDs
ETR Extensions	1 to 6	<p>Each ETR phone can be used for an ETR or analog phone. Support for ETR 34D phone is limited to a maximum of 2 per ETR6 card and 4 in total.</p> <ul style="list-style-type: none"> • REN 1. • DTMF dialing only. • Message waiting indication 51V stepped. 	<p>No status LED are used for ETR ports.</p> <ul style="list-style-type: none"> • LED1 is used for base card status: <ul style="list-style-type: none"> • Red On = Error • Red Slow Flash = Initializing. <ul style="list-style-type: none"> • Red Flash every 5 seconds = Card okay. • Red Fast Flash = System shutdown.

Port Type	Ports	Features	Port LEDs
		<ul style="list-style-type: none"> • ICLID mode Bellcore 202. 	
EF	7 to 8	<ul style="list-style-type: none"> • If fitted with an IP500 Trunk Daughter card, during power failure both these ports are connected to analog trunk port 12. • Supports ICLID modes DTMFA, DTMFC, DTMFD, FSK and UK20. • REN 2 (1 for external bell device). • Off-Hook current: 25mA • Ring Voltage: 40V. • Intended for connection to two-wire analog phones, the ports do not include a ringing capacitor. For connection to 4-wire analog phones, connection should be via a master socket with ringing capacitors. 	No status LEDs are used for analog phone extensions.
Optional Trunk Ports	9 to 12	The ETR-6 can be fitted with an Analog Trunk card	<p>LED use depends daughter card type fitted.</p> <ul style="list-style-type: none"> • LED 9 is used for daughter card status. <ul style="list-style-type: none"> • Red On = Error • Red Slow Flash = Initializing. • Red Flash every 5 seconds = Card okay. • Red Fast Flash = System shutdown. <p>Analog Trunk Daughter Card</p> <ul style="list-style-type: none"> • Green on: Card fitted. • Green flashing: Trunk in use. <p>PRI Trunk Daughter Card</p> <ul style="list-style-type: none"> • Off: No trunk present. • Green on: Trunk present. • Green flashing: Trunk in use. • Red/Green Fast Flash (port 9) or Green Fast Flash (port 10): Alarm indication signal (AIS) from the trunk remote end. • Red with Green Blink (port 9) or Green Blink (port 10): Port in loopback mode (set through IP Office System Monitor).

Name	Description	Part Number
I PO 500v2 EXTN CARD ETR-6	IP Office 500v2 EXTN CARD ETR-6	700476039

4.3.4 ATM Combination Card

This card is used to add a combination of ports to the IP 500v2 control unit.

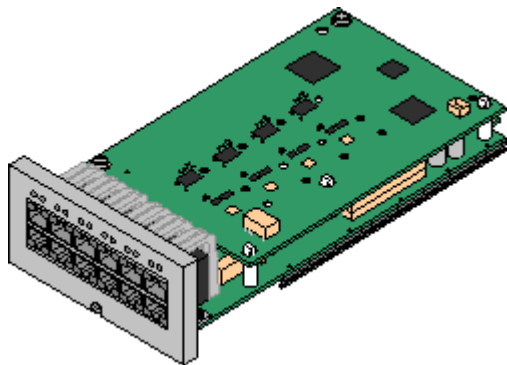

- Supports
 - 6 Digital Station ports.
 - 2 Analog Extension ports.
 - 4 Analog Trunk ports.
 - 10 VCM channels.
- Maximum per Control Unit: 2.
- IP500 Daughter Card Support: ✓ 1. The trunk daughter card is pre-installed and cannot be replaced with another card type.

Port Type	Ports	Features	Port LEDs
Digital Station	1 to 6	Phrase IP500 Analog Ports Provides DS ports for digital stations (except 4406D, 4412D and 4424D).	<ul style="list-style-type: none"> • Green On - Phone detected. • LED1 is used for base card status: <ul style="list-style-type: none"> • Red On = Error • Red Slow Flash = Initializing. • Red Flash every 5 seconds = Card okay. • Red Fast Flash = System shutdown.
Analog Extension	7 to 8	<ul style="list-style-type: none"> • Supports ICLID modes DTMFA, DTMFC, DTMFD, FSK and UK20. • REN 2 (1 for external bell device). • Off-Hook current: 25mA • Ring Voltage: 40V. • Intended for connection to two-wire analog phones, the ports do not include a ringing capacitor. For connection to 4-wire analog phones, connection should be via a master socket with ringing capacitors. • During power failure extension port 8 is connected to the analog trunk port 12. 	No status LEDs are used for analog phone extensions.
Analog Trunk	9 to 12	<ul style="list-style-type: none"> • DTMF, ICLID, Busy tone detection. • Over-voltage and lightning protection. • DTMF and LD dialing. • Adjustable echo cancellation (default 16ms). Selectable to Off, 8, 16, 32, 64 and 128 milliseconds. 	<ul style="list-style-type: none"> • Green on: Card fitted. • Green flashing: Trunk in use. • LED 9 is used for daughter card status. <ul style="list-style-type: none"> • Red On = Error • Red Slow Flash = Initializing. • Red Flash every 5 seconds = Card okay. • Red Fast Flash = System shutdown.

Name	Description	Part Number
I PO 500v2 COMBINATION CARD ATM	IP Office 500v2 COMBINATION CARD ATM	700476013

4.4 Trunk Cards

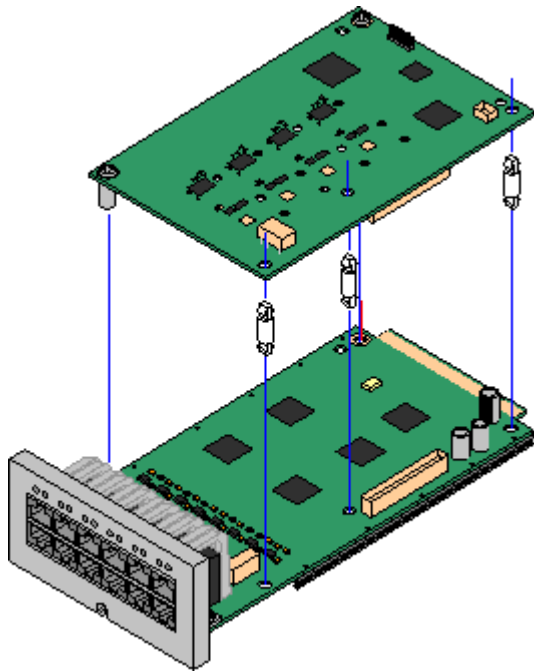

IP Office 500 Analog Trunk Daughter Card

IP Office 500 daughter trunk cards can be fitted to IP Office 500 base cards to provide support for trunk. The daughter card uses the physical ports provided on the front panel of the base card for cable connection.

The addition of an IP Office 500 daughter card is supported on any IP Office 500 base card except the IP Office 500 Legacy Card Carrier base card.

For those base card that support daughter cards, there are no restrictions on the combination of card types. However in systems with both analog phone base cards and analog trunk daughter cards, combining the two types is recommended as it then provides analog power failure support for one trunk/extension.

Each daughter card is supplied two pre-fitted metal pillars and 3 plastic pillars. Two screws and washers for final attachment of the metal pillars to the base card are also included.

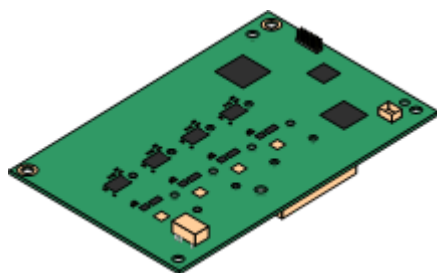

IP Office 500 PRI-U Trunk Daughter Card

This card can be added to IP Office 500 base cards. It enables that base card to then also support four analog loop-start trunks.

- When fitted to an IP Office 500 Analog Phone 8 base card, the combination supports 1 power failure extension to trunk (loop-start only) connection.
- Maximum: 2 per IP Office 500v2 control unit.

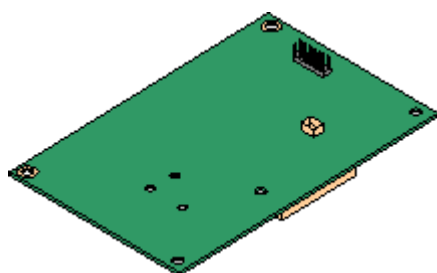

This card can be added to an IP Office 500 base card. The card is a universal card that can be configured in software for T1 robbed bit, T1 PRI or E1R2. The card is available in single and dual port variants.

- Maximum: 4 per IP Office 500v2 control unit.
- The IP Office 500 PRI-U card supports E1, T1 and E1-R2 PRI modes. The Essential Edition - PARTNER Version system supports 8 unlicensed B-channels on each IP Office 500 PRI-U port fitted. Additional B-channels, up to the capacity of ports installed and PRI mode selected require IP Office 500 Universal PRI (Additional Channels) licenses added to the configuration. These additional channels consume the licenses based on which additional channels are configured as in-service from port 9 of slot 1 upwards. D-channels are not affected by licensing.

4.4.1 Analog Trunk Card

This card can be added to an IP500 base card to provide that card with support for 4 loop-start analog trunks. This card can be fitted to any IP500 base card except the IP500 Legacy Carrier card and IP500 4-Port Expansion card.

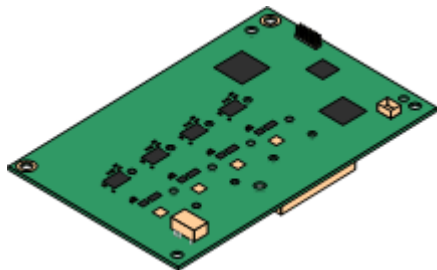

- Ports/Channels
4 Loop-start analog trunk ports. Connections via the host IP500 base card.
- DTMF, ICLID, Busy tone detection.
- Over-voltage and lightning protection (may still require additional protection equipment see [Lightning Protection](#) / [Out-of-Building Connections](#).)
- DTMF and LD dialing.
- Adjustable echo cancellation (default 16ms). Selectable to Off, 8, 16, 32, 64 and 128 milliseconds.
- Power Failure Port
Regardless of the IP500 card hosting it, during power failure pins 4 and 5 of port 12 are connected to pins 7 and 8. In addition, when fitted to an IP500 Analog Phone 8 base card, during power failure extension port 8 is connected to the analog trunk port 12.
- License: No license required.
- Maximum per IP500 Control Unit: 4.
- IP Office Software Level: 4.0+.

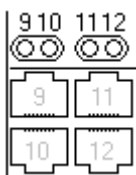

Daughter Card Ports (9-12)

The LEDs for ports 9 to 12 of the IP500 base card are used as follows:

- Green on: Card fitted.
- Green flashing: Trunk in use.
- LED 9 is used for daughter card status.
- Red On = Error
- Red Flash every 5 seconds = Card okay.
- Red Slow Flash = Initializing.
- Red Fast Flash = System shutdown.

Name	Description	Part Number
I PO 500 Trnk Anlg 4 Uni	IP Office 500 Trunk Card Analog 4 Universal	700417405

4.4.2 PRI Trunk Cards

This card can be added to an IP500 base card to provide that card with support for PRI trunks. The card is available in single port or dual port variants.

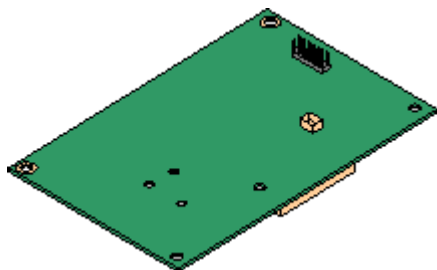

- Ports/Channels
1 or 2 [PRI trunk ports](#). Each port supports the following PRI line types. On dual port cards both ports will be the same line type. The line type selection can be changed using IP Office [Manager](#).
 - E1R2 PRI (30B channels per port).
 - T1 robbed bit (24B channels per port) or T1 PRI (23B+D channels per port).
- The required mode can be selected within IP Office Manager by right-clicking on the line icon and selecting Change Universal PRI Card Line Type and then selecting the required line type.
- Physical trunk connection is via ports 9 and 10 of the host IP500 base card.
- Port 11 and 12 can be used as test points for connection of test and monitoring equipment for the adjacent port.

- Licenses
The Essential Edition - PARTNER Version system supports 8 unlicensed B-channels on each IP500 PRI-U port fitted. Additional B-channels, up to the capacity of ports installed and PRI mode selected require IP500 Universal PRI (Additional Channels) licenses added to the configuration. These additional channels consume the licenses based on which additional channels are configured as in-service from port 9 of slot 1 upwards. D-channels are not affected by licensing.
- Maximum per Control Unit: 4.
- Software Level: 6.0+.

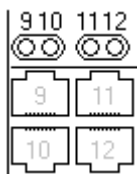

Daughter Card Ports (9-12)
The LEDs for ports 9 to 12 of the IP500 base card are used as follows:

- Off: No trunk present.
- Green on: Trunk present.
- Green flashing: Trunk in use.
- Red/Green Fast Flash (port 9) or Green Fast Flash (port 10): Alarm indication signal (AIS) from the trunk remote end.
- Red with Green Blink (port 9) or Green Blink (port 10): Port in loopback mode (set through IP Office System Monitor).
- LED 9 is used for daughter card status.

- Red On = Error
- Red Slow Flash = Initializing.
- Red Flash every 5 seconds = Card okay.
- Red Fast Flash = System shutdown.

Name	Description	Part Number
IPO 500 TRNK PRI 1 UNI	IP Office 500 Trunk Card Primary Rate 1 Universal	700417439
IPO 500 TRNK PRI 2 UNI	IP Office 500 Trunk Card Primary Rate 2 Universal	700417462

4.5 Expansion Modules

The Essential Edition - PARTNER Version control unit can support one extension unit as follows:

- Digital Station ([DS](#)) module.
- or
- [Phone](#) module.

4.5.1 Digital Station

IPO 500 Digital Station modules can be used to add additional DS ports to an Essential Edition - PARTNER Version system. Note that this requires the IP Office control unit to be configured with an IP Office 500 Upgrade Standard to Professional license.

The module is referred to as the IPO 500 Digital Station 16.

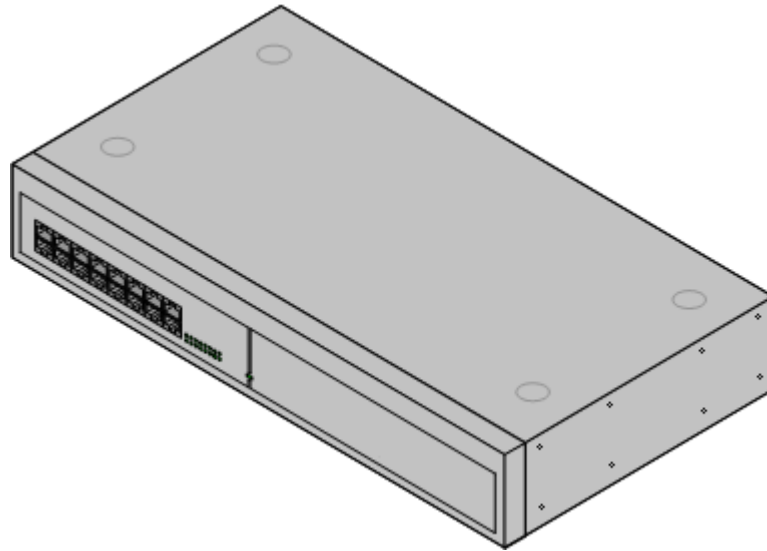

IPO 500 Digital Station Connections

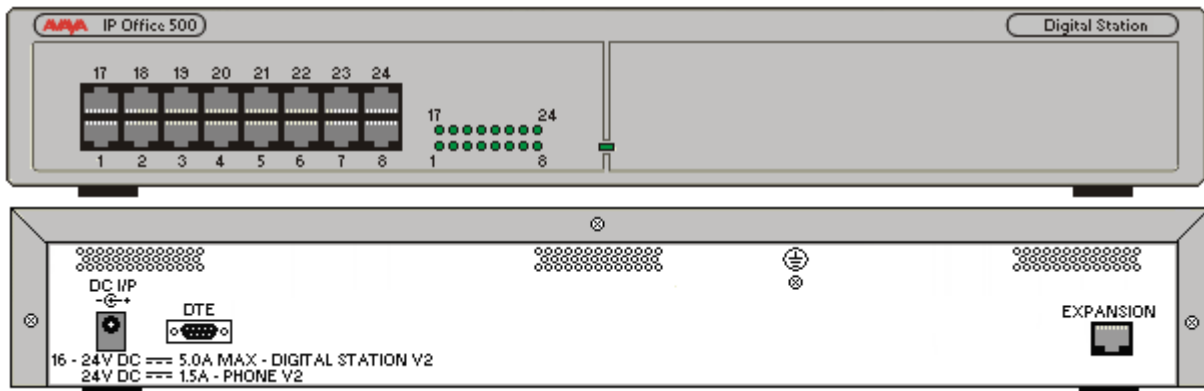

Ports	Description
DC I/P	DC power input port. Used for connection of the power lead from an Avaya earthed 60W external power supply unit supplied with the expansion module. A locale specific IEC60320 C13 power cord for the external PSU is required but is not supplied with the module.
DS	RJ45 sockets. Digital Station port. Used for connection of IP Office supported DS phones . If connected to an out-of-building extension , the connection must be made via additional IROB barrier devices in addition to the buildings primary protection. The module must also be connected to a protective ground.
DTE	9-Way D-Type socket. For Avaya use only.
EXPANSION	RJ45 Socket. Used for direct connection to an Expansion port on an IP Office control unit using the Expansion Interconnect cable supplied with the module.
	Protective Ground point. Use of a protective ground is required for all installations, see Grounding (Earthing) . Where the module is connected to analog extensions in another building, an IP Office Phone Barrier Box V2 (101V) is required at both ends, see Lightning Protection/Out-of-Building Connections .

All expansion modules are supplied with a base software level and should be upgraded to match the core software of the control unit in the Essential Edition - PARTNER Version system.

Item	Variant	Country	Part number
IPO 500 Digital Station	16 Ports	All	700449499
	CEE7/7	Europe	700289762
	BS1363	United Kingdom	700289747
	NEMA5-15P	America	700289770
IP Office 500Rack Mounting Kit		All	700429202

Expansion modules include an external power supply unit (PSU) and an appropriate interconnect cable. They do not include a locale specific power cord for the external PSU or any phone extension cables.

4.5.2 Phone Module

IPO 500 Phone modules can be used to add extra PHONE ports to an IP Office Partner® Version system. Note that this requires the IP Office 500 control unit to be configured with an IP Office 500 Upgrade Standard to Professional license.

The module is referred to as the IPO 500 Phone 16.

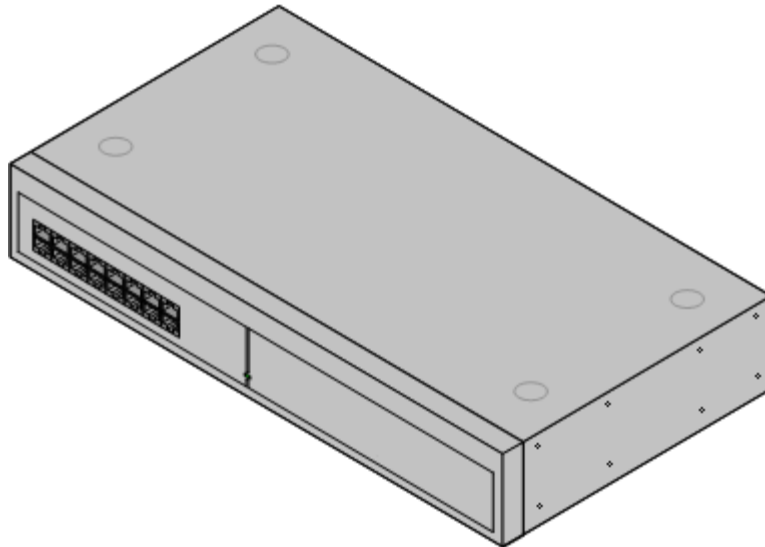

Feature	Details
Software Level	IP Office core software level 2.1(36) minimum. Bin file = dvpots.bin.
Included	Power supply unit (see below) and Expansion Interconnect cable.
Power Supply	The module is supplied with a Earthed 3-Pin, 60W external power supply unit. The PSU has an integral power cord for connection to the module DC I/P socket. A locale specific IEC60320 C13 power cord for the external PSU is required but is not supplied with the module.
Mounting	The module is designed as a free-standing module that can be stacked on or under other IP Office modules. The module can be rack mounted in a 19" rack system using the optional IP Office 500Rack Mounting Kit .
Dimensions	Width: 445mm/17.5". Depth: 245mm/9.7". Height: 71mm/2.8".
Weight	Unboxed: 3.1Kg/6.94lbs. Boxed: 4.4Kg/9.7lbs. (Based on Phone 30 V2)

IPO 500 Phone Connections

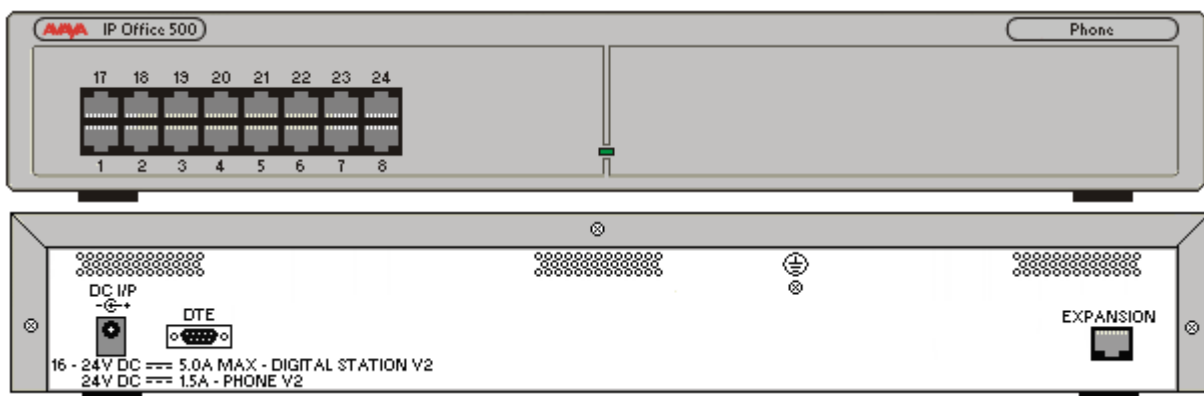

Ports	Description
DC I/P	DC power input port. Used for connection of the power lead from an Avaya earthed 60W external power supply unit supplied with the expansion module. A locale specific IEC60320 C13 power cord for the external PSU is required but is not supplied with the module.
DTE	9-Way D-Type socket. For Avaya use only.
EXPANSION	RJ45 Socket. Used for direct connection to an Expansion port on an IP Office control unit using the Expansion Interconnect cable supplied with the module.

PHONE (front panel)	RJ45 sockets. Used for connection of analog phones. Intended for two-wire analog phones. For connection to 4-wire analog phones connection should be via a master socket with ringing capacitors. If connected to an out-of-building extension , the connection must be made via additional IP Office Barrier Boxes in addition to the buildings primary protection. The module must also be connected to a protective ground.
	Protective Ground point. Use of a protective ground is required for all installations, see Grounding (Earthing) . Where the module is connected to analog extensions in another building, an IP Office Phone Barrier Box V2 (101V) is required at both ends, see Lightning Protection/Out-of-Building Connections .

All expansion modules are supplied with a base software level and should be upgraded to match the core software of the control unit in the Essential Edition - PARTNER Version system.

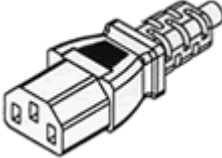
Item	Variant	Country	Part number
IPO 500 Phone	16 Ports	All	700449507
	CEE7/7	Europe	700289762
	BS1363	United Kingdom	700289747
	NEMA5-15P	America	700289770
	China	China	700261977
IP Office 500Rack Mounting Kit		All	700429202

Expansion modules include an external power supply unit (PSU) and an appropriate interconnect cable. They do not include a locale specific power cord for the external PSU or any phone extension cables.

4.6 Telephones

Essential Edition - PARTNER Version supports the following phones and phone add-ons. Availability may be subject to local restrictions.

- [ETR 34](#), [18](#), [6](#), [34D](#), [18D](#), [6D](#)
- [3910](#), [3920](#)
- [1403](#), [1408](#), [1416](#)
- [POTS](#) telephones. Essential Edition - PARTNER Version supports the AVAYA 62XX range
- [BM32 Buttons](#)
- Digital station connects to the Essential Edition - PARTNER Version via a DS port.

4.6.1 1416

This phone is supported by the Essential Edition - PARTNER® Version system.

1416	Feature	1416
	Connects via	DS port.
	Programmable Buttons	✓ 16 (14) bottom two are fixed as Intercom)
	Headset Socket	✓
	Hands free Speaker/ Microphone	✓/✓
	Message Waiting Lamp	✓
	Display	4 x 24 Backlit.
	Supported Add-Ons	BM32 x 2.
	Upgrade able Firmware	✓

Fixed Function Keys

✓ SPEAKER	✓ HEADSET	✓ MUTE	✓ VOLUME UP	✓ CONTACTS
✓ MESSAGE	✓ HOLD	✓ TRANSFER	✓ VOLUME DOWN	✓ CALL LOG
✓ DROP	✓ REDIAL	✓ CONFERENCE	✓ MENU	

Name	Description
Message Waiting Indicator	An illuminated red light in the upper-right corner of your phone indicates you have voicemail messages waiting. If Visual Alerting is enabled, this light flashes when you receive an incoming call.
Avaya Menu	Press the A button to access the Avaya menu. Press the A button twice to exit the Avaya menu. The Avaya menu provides options that allow you to customize phone settings, select the display language, view network information, and log out.
Redial	Press Redial to dial the last number you dialed.
Hold	Press Hold to put the active call on hold.
Conference	Press Conference to add another party to an existing call.
Transfer	Press Transfer to transfer a call to another number.
Drop	Press Drop to drop the active call. While on a conference call, press Drop to drop the last person added to the conference call.

Name	Description
Volume	Press + or - on the volume button while active on the handset or speaker to adjust the volume. To adjust the volume of the ringer, press + or - on the volume button while the handset and speaker are inactive.
Mute	Press Mute to mute a call in progress. To take a call off mute, press Mute again.
Speaker	Press Speaker to use the speakerphone. To take a call off speakerphone, lift the handset.
Feature Buttons and Call/Line Appearance Buttons	There are 3 buttons. The first two of them are fixed as Intercom, the third can be programmed by the system administrator as either call/line appearance buttons or feature buttons. Press a call/line appearance button to make or answer a call or resume a call on hold. Press a labeled feature button to enable or disable that feature. The feature button provides access to an Avaya call management system feature that has been administered for your extension. The green LED next to the feature button indicates if the feature is currently on or off. If the light is on, the feature is on.

4.6.2 1408

This phone is supported with Essential Edition - PARTNER® Version

1408	Feature	1408
	Connects via	DS port.
	Programmable Buttons	✓ 8 (6 bottom two are fixed as Intercom)
	Headset Socket	✓
	Hands free Speaker/Microphone	✓/✓
	Message Waiting Lamp	✓
	Display	3 x 24 backlit.
	Supported Add-Ons	None.
	Upgrade able Firmware	✓

Fixed Function Keys

✓ SPEAKER	✓ HEADSET	✓ MUTE	✓ VOLUME UP	✓ CONTACTS
✓ MESSAGE	✓ HOLD	✓ TRANSFER	✓ VOLUME DOWN	✓ CALL LOG
✓ DROP	✓ REDIAL	✓ CONFERENCE	✓ MENU	

Name	Description
Message Waiting Indicator	An illuminated red light in the upper-right corner of your phone indicates you have voicemail messages waiting. If Visual Alerting is enabled, this light flashes when you receive an incoming call.
Avaya Menu	Press the A button to access the Avaya menu. Press the A button twice to exit the Avaya menu. The Avaya menu provides options that allow you to customize phone settings, select the display language, view network information, and log out.
Redial	Press Redial to dial the last number you dialed.
Hold	Press Hold to put the active call on hold.
Conference	Press Conference to add another party to an existing call.
Transfer	Press Transfer to transfer a call to another number.
Drop	Press Drop to drop the active call. While on a conference call, press Drop to drop the last person added to the conference call.

Name	Description
Volume	Press + or - on the volume button while active on the handset or speaker to adjust the volume. To adjust the volume of the ringer, press + or - on the volume button while the handset and speaker are inactive.
Mute	Press Mute to mute a call in progress. To take a call off mute, press Mute again.
Speaker	Press Speaker to use the speakerphone. To take a call off speakerphone, lift the handset.
Feature Buttons and Call/Line Appearance Buttons	There are 3 buttons. The first two of them are fixed as Intercom, the third can be programmed by the system administrator as either call/line appearance buttons or feature buttons. Press a call/line appearance button to make or answer a call or resume a call on hold. Press a labeled feature button to enable or disable that feature. The feature button provides access to an Avaya call management system feature that has been administered for your extension. The green LED next to the feature button indicates if the feature is currently on or off. If the light is on, the feature is on.

4.6.3 1403

The 1403 IP telephone is a multi line IP telephone for use with Avaya IP Office. The 1403 IP telephone puts convenient features and capabilities at your fingertips, including a Conference, Transfer, Hold, and Redial button and a menu of options and settings to customize your phone.

Not all features described in this user guide may be available on your telephone. If you find that a feature is not available, contact your system administrator.



Name	Description
Message Waiting Indicator	An illuminated red light in the upper-right corner of your phone indicates you have voicemail messages waiting. If Visual Alerting is enabled, this light flashes when you receive an incoming call.
Avaya Menu	Press the A button to access the Avaya menu. Press the A button twice to exit the Avaya menu. The Avaya menu provides options that allow you to customize phone settings, select the display language, view network information, and log out.
Redial	Press Redial to dial the last number you dialed.
Hold	Press Hold to put the active call on hold.
Conference	Press Conference to add another party to an existing call.
Transfer	Press Transfer to transfer a call to another number.
Drop	Press Drop to drop the active call. While on a conference call, press Drop to drop the last person added to the conference call.
Volume	Press + or - on the volume button while active on the handset or speaker to adjust the volume. To adjust the volume of the ringer, press + or - on the volume button while the handset and speaker are inactive.
Mute	Press Mute to mute a call in progress. To take a call off mute, press Mute again.
Speaker	Press Speaker to use the speakerphone. To take a call off speakerphone, lift the handset.
Feature Buttons and Call/Line Appearance Buttons	There are 3 buttons. The first two of them are fixed as Intercom, the third can be programmed by the system administrator as either call/line appearance buttons or feature buttons. Press a call/line appearance button to make or answer a call or resume a call on hold. Press a labeled feature button to enable or disable that feature. The feature button provides access to an Avaya call management system feature that has been administered for your extension. The green LED next to the feature button indicates if the feature is currently on or off. If the light is on, the feature is on.

4.6.4 ETR34D

This phone is only supported by an [ETR-6 card](#) in the Essential Edition - PARTNER Version system.

All 'Refresh' and 'Euro Style' variants of the phone are supported. An additional analog device using the same extension number can be connected via the ETR phone AUX socket.

The Essential Edition - PARTNER Version system supports up to maximum 4 ETR34D handsets (2 per ETR-6 module)



The ETR PARTNER telephones have fixed buttons that are already imprinted and programmable buttons that you can program with outside lines, extension numbers, outside numbers, or system features. The telephones also have a display, which provides feedback messages and prompts from the system.

ETR34D Telephone Features

Feature	34
Number of programmable buttons with lights	32
Number of programmable buttons without lights	4
Key mode line button capacity	32
Intercom Buttons	2
Display	Yes
Speakerphone	Yes

4.6.5 ETR18D

This phone is only supported by an [ETR-6 card](#) in the Essential Edition - PARTNER Version system.

All 'Refresh' and 'Euro Style' variants of the phone are supported. An additional analog device using the same extension number can be connected via the ETR phone AUX socket.



The ETR PARTNER telephones have fixed buttons that are already imprinted and programmable buttons that you can program with outside lines, extension numbers, outside numbers, or system features. The telephones also have a display, which provides feedback messages and prompts from the system.

ETR18D Telephone Features

Feature	18D
Number of programmable buttons with lights	16
Number of programmable buttons without lights	4
Key mode line button capacity	16
Intercom Buttons	2
Display	Yes
Speakerphone	Yes

4.6.6 ETR6D

This phone is only supported by an [ETR-6 card](#) in the Essential Edition - PARTNER Version system.

All 'Refresh' and 'Euro Style' variants of the phone are supported. An additional analog device using the same extension number can be connected via the ETR phone AUX socket.



The ETR PARTNER telephones have fixed buttons that are already imprinted and programmable buttons that you can program with outside lines, extension numbers, outside numbers, or system features. The telephones also have a display, which provides feedback messages and prompts from the system.

ETR6D Telephone Features

Feature	6D
Number of programmable buttons with lights	4
Number of programmable buttons without lights	0
Key mode line button capacity	4
Intercom Buttons	2
Display	Yes
Speakerphone	Yes

4.6.7 ETR34

This phone is only supported by an [ETR-6 card](#) in the Essential Edition - PARTNER Version system.

All 'Refresh' and 'Euro Style' variants of the phone are supported. An additional analog device using the same extension number can be connected via the ETR phone AUX socket.

The ETR PARTNER® Version telephones have fixed buttons that are already imprinted and line buttons that you can press to connect to an inside (intercom) or outside line. If a line button is not assigned as an intercom or outside line button, you can program an extension number or a feature on it.

ETR34 Telephone Features

Feature	
Number of programmable buttons with lights	32
Number of programmable buttons without lights	4
Key mode line button capacity	24
Intercom Buttons	2
Display	No
Speakerphone	Yes

4.6.8 ETR18

This phone is only supported by an [ETR-6 card](#) in the Essential Edition - PARTNER Version system.

All 'Refresh' and 'Euro Style' variants of the phone are supported. An additional analog device using the same extension number can be connected via the ETR phone AUX socket.



The ETR PARTNER® Version telephones have fixed buttons that are already imprinted and line buttons that you can press to connect to an inside (intercom) or outside line. If a line button is not assigned as an intercom or outside line button, you can program an extension number or a feature on it.

ETR18 Telephone Features

Feature	
Number of programmable buttons with lights	16
Number of programmable buttons without lights	4
Key mode line button capacity	16
Intercom Buttons	2
Display	No
Speakerphone	Yes

4.6.9 ETR6

This phone is only supported by an [ETR-6 card](#) in the Essential Edition - PARTNER Version system.

All 'Refresh' and 'Euro Style' variants of the phone are supported. An additional analog device using the same extension number can be connected via the ETR phone AUX socket.



The ETR PARTNER® Version telephones have fixed buttons that are already imprinted and line buttons that you can press to connect to an inside (intercom) or outside line. If a line button is not assigned as an intercom or outside line button, you can program an extension number or a feature on it.

ETR6 Telephone Features

Feature	
Number of programmable buttons with lights	4
Number of programmable buttons without lights	0
Key mode line button capacity	4
Intercom Buttons	2
Display	No
Speakerphone	Yes

4.6.10 3910

This single station DECT phone is supported on an IP 500v2 control unit running in Partner® Version mode. The base station uses an ETR port for connection to the IP Office. This phone is no longer available from Avaya and has been superseded by the 3920.



4.6.11 3920

The Avaya 3920 is a single station DECT phone wireless telephone, designed specifically for small businesses

Utilizing next-generation digital technology (DECT 6.0), the Avaya 3920 wireless telephone offers high quality voice communication. DECT, unlike other wireless technologies, uses a dedicated frequency that prevents interference from other devices and delivers increased coverage in warehouse and campus-like environments.

* Coverage area depends on building construction and environmental conditions.

The base station uses an ETR port for connection to Essential Edition - PARTNER® Version.



4.6.12 POTS

Essential Edition - PARTNER Version systems should support most types of analog phone, however it has not been possible for Avaya to test widely.

There are differences in behavior between ETR6 POTs and PHONE/Combination POTs that should be noted:

- ETR6 POTs are defined as POTs directly connected to the ETR-6 module and not to the AUX jack on the back of an ETR digital telephone. PHONE/Combination POTs are POTs connected to PHONE or Combination system modules.
- PHONE/Combination POTs cannot have line appearances whilst ETR6 POTs can. ETR6 POTs having line appearances is consistent with PARTNER® ACS operation.
- PHONE/Combination POTs ring with ring patterns consistent with IP Office whilst ETR6 POTs ring with ring patterns consistent with PARTNER® ACS:
 - Intercom calls to PHONE/Combination POTs are one long ring while on ETR6 POTs, they are one long ring followed immediately by one short ring.
 - Outside calls on PHONE/COMBO POTs are one very long ring whilst on ETR6 POTs they are just one long ring.
 - Transferred calls on PHONE/COMBO POTs are the same ring as the base call type, inside or outside, while on ETR6 POTs they are one long ring followed immediately by two short rings.
 - Returning held calls on PHONE/Combination POTs are three short rings whilst on ETR6 POTs they are one long ring followed immediately by two short rings.
 - Returning parked calls on PHONE/Combination POTs ring with the base call ringing pattern whilst on ETR6 POTs they ring with the same ring as the returning held call.
- ETR6 POTs cannot place calls on hold for extended periods like PHONE/Combination POTs. This is consistent with PARTNER® ACS POT behavior. If a call is placed on hold and the ETR6 POT user hangs up, the call immediately returns and rings with the returning held call ringing pattern described above.
- The PE Automatic Line Selection feature applies to ETR6 POTs whilst it does not apply to PHONE/Combination POTs. When a PHONE/Combination POTs user dials 9 to obtain an outside line, it looks for an available line starting at line one and progressing upwards. When an ETR6 POTs user dials 9 to obtain an outside line, it uses the ALS programming to select an available line potentially skipping some lines.
- Call Waiting Tone is consistent between ETR6 POTs and PHONE/Combination POTs, which is one short beep of tone. This is inconsistent (but acceptable) with PARTNER® ACS which is two short beeps of tone.

4.6.13 Phone Add-Ons

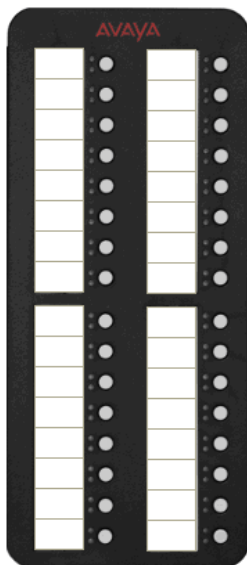

The 1416 phone supports button modules which provided the phone with additional programmable buttons.

The number of button modules supported per phone and per system are as follow:

- DBM32: (1416)
Up to 32 DBM32s supported (32 buttons each, up to 1024 buttons).

The maximum combined number of buttons per system is 512, regardless of whether the buttons are programmed or not.

This add on provides an additional 32 twin-LED programmable buttons for 1416 phones. The BM32 does not require its own power supply connection, instead it draws power from the phone to which it is connected.

- Only two BM32 units can be connected in a chain from a single 1416. Up to three 1416 telephones with BM32s are supported, i.e. 6 BM32s.
- To support a BM32 the phone must be powered by an individual 1600 Series Power Adapter.
- Up to a maximum of 16 BM32 units are supported on the whole Essential Edition - PARTNER Version system.
- The BM32 buttons cannot be used for appearance functions such as call.

Item	Part number
BM32 BUTTON MODULE	700415573
Accessories	
1600 SERIES BM32 CABLE - REPLACEMENT	700415581
1600 SERIES BM32 BOND BRIDGE - REPLACEMENT	700415599
1616/BM32 PLASTIC LABEL COVERS (20) – REPLACEMENT	700415672
1600 SERIES BM32 FLIP STAND - REPLACEMENT	700432800
Paper Labels	
1616/BM32 PAPER DESI LABELS - PACKAGE OF 50 LABELS (8.5" x 11")	700415656
1616/BM32 PAPER DESI LABELS - PACKAGE OF 50 LABELS (A4)	700434236

4.7 Out of Building Connections

The following are the only supported scenarios in which wired extensions and devices outside the main building can be connected to the Essential Edition - PARTNER Version system. In these scenarios, additional protection, in the form of protective grounding and surge protectors, must be fitted.

⚠ The fitting of additional protection does not remove the risk of damage. It merely reduces the chances of damage.

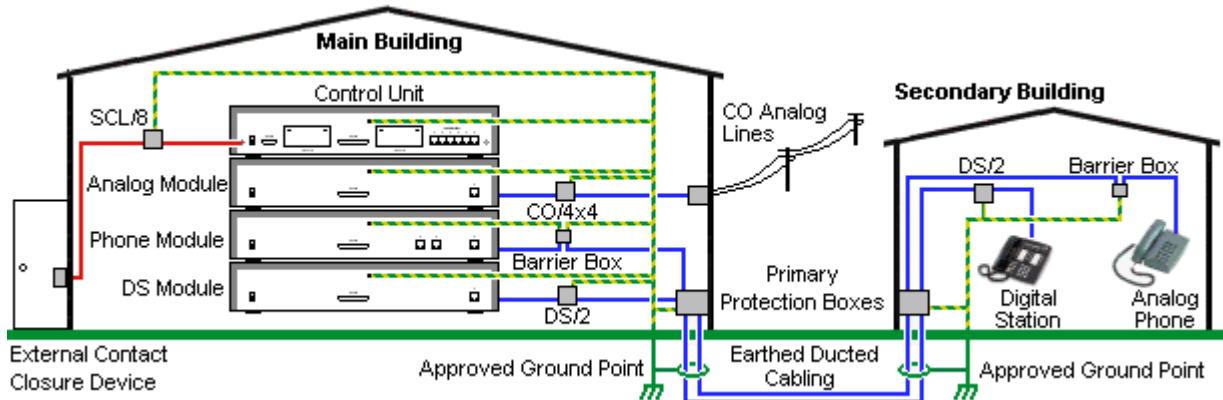

Cabling Requirements

- Cables of different types, for example trunk lines, extensions, ground and power connections, should be kept separate.
- All cabling between building should be enclosed in grounded ducting. Ideally this ducting should be buried.
- A Primary Protection Box must be provided at the point where the cables enter the building. This should be three point protection (tip, ring and ground). Typically this would be gas tube protection provided by the local telephone company. The ground wire must be thick enough to handle all the lines being affected by indirect strike at the same time.

Connection Type	Protection Device Type	Requirement
DS Phone Extensions ⚠ Digital Station Expansion module DS ports only.	ITWLinx towerMAX DS/2 Supports up to 4 connections. (This device was previously referred to as the Avaya 146E).	<ul style="list-style-type: none"> • Connection from the expansion module to the phone must be via a surge protector at each end and via the primary protection point in each building. • The IP Office expansion module and control unit and IROB devices must be connected to the protective ground point in their building.
Analog Phone Extensions ⚠ Phones Expansion module (POT or PHONE) ports only.	IP Office Barrier Box Supports a single connection. Maximum of 16 on any expansion module.	<ul style="list-style-type: none"> • The between building connection must be via earthed ducting, preferable underground. The cable must not be exposed externally at any point.
Analog Trunks	ITWLinx towerMAX CO/4x4 Supports up to 4 two-wire lines. (This device was previously referred to as the Avaya 146C).	For locations where the risk of lightning strikes is felt to be high, additional protection of incoming analog trunks is recommended.
External Output Switch	ITWLinx towerMAX SCL/8 (This device was previously referred to as the Avaya 146G)	Connections from an IP Office Ext O/P port to an external relay device must be via a surge protector.

* The towerMAX range of devices are supplied by ITWLinx (<http://www.itwlinx.com>).

4.7.1 DS Phones

When digital phone extensions are required in another building, additional In-Range Out-Of-Building (IROB) protective equipment must be used. For phones connected to IP Office DS ports, the supported device supplied by ITWLinx is a towerMAX DS/2* module. This IROB device was previous badged by Avaya as the 146E IROB.

The protection device should be installed as per the instructions supplied with the device. The ground points on the IP Office control unit and the DS modules must be connected to a protective ground using 18AWG wire with a green and yellow sleeve.

Typically the IROB

2 RJ45 EQUIPMENT ports are straight through connected to the 2 RJ45 LINE ports. This allows existing RJ45 structured cabling, using pins 4 and 5, to be used without rewiring for up to two DS connection. However each of these ports can be used to connect a second extension using pins 3 and 6.

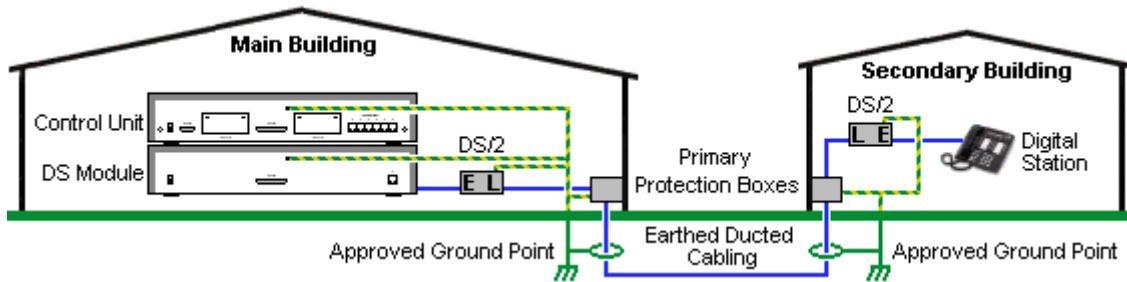

LINE	Signal	EQUIPMENT
	1	Not used.
	2	Not used.
	3	Ring II (Optional)
	4	Ring I
	5	Tip I
	6	Tip II (Optional)
	7	Not used.
	8	Not used.

LINE	Signal	EQUIPMENT
1		1
2		2
3		3
4		4
5		5
6		6
7		7
8		8

* The towerMAX range of devices are supplied by ITWLinx (<http://www.itwlinx.com>).

4.7.2 Analog Phone Barrier Box

Where analog phone extensions are required in another building, additional protective equipment must be used, in the form of IP Office Phone Barrier Boxes and protective earth connections.

- The correct IP Office specific barrier boxes must be used. These modules have been designed specifically for the signalling voltages used by the Essential Edition - PARTNER Version system:
 - Only the IP Office Phone Barrier Box V2 should be used.
 - No other type of analog phone barrier box should be used.
- Where more than 3 barrier boxes are required in a building, they must be rack mounted using a [Barrier Box rack mounting kit](#).
- A maximum of 16 barrier boxes can be used with any Phone module.
- CAUTION: PHONE (POT) ports on the front of control units must not be used for extensions that are external to the main building.

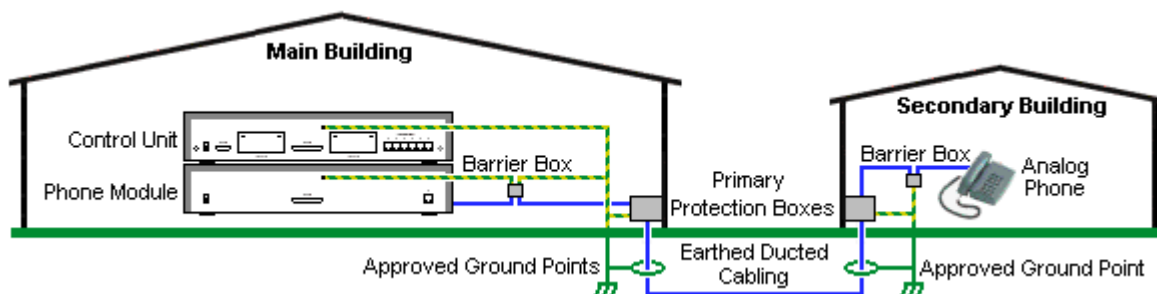

Main Building	Barrier Box	Secondary Building
---------------	-------------	--------------------

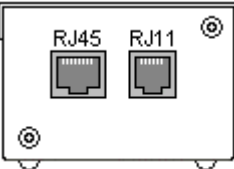
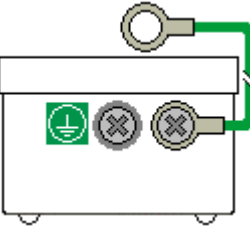
<ul style="list-style-type: none"> • RJ11: Connect to PHONE (POT) port on the Phone module using cable supplied with the barrier box. • RJ45: Connect to the secondary building barrier box via primary protection in both buildings. 		<ul style="list-style-type: none"> • RJ11: Connect to analog phone. Cable not supplied. • RJ45: From main building via primary protection in both buildings.
<ul style="list-style-type: none"> • Center Screw: Connect to main building protective ground (or ground terminal of Barrier Box Rack Mounting Kit). Use 18AWG (minimum) wire with a green and yellow sleeve. • Right-Hand Screw: Connect to ground point on Phone module using ground cable supplied with barrier box. 		<ul style="list-style-type: none"> • Center Screw: Connect to main building protective ground. Use 18AWG (minimum) wire with a green and yellow sleeve. • Right-Hand Screw: Not used.

Wires from external telephone going directly to the barrier boxes must be kept apart, that is not routed in the same bundle:

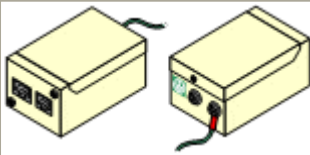
IP Office Barrier Boxes	Part number
 <p>IP Office 500 Phone Barrier Box (81V) Use with Phone V1 module. Includes an RJ45 to RJ11 cable and a functional earth lead.</p>	700293897
<p>IP Office 500 Phone Barrier Box V2 (101V) Use with Phone V2 module. Includes an RJ45 to RJ11 cable and a functional earth lead.</p>	700385495
Barrier Box Rack Mounting Kit	700293905

4.7.3 Rack Mounting Barrier Boxes

Where more than 3 Phone Barrier Boxes are used they must be rack mounted. The Barrier Box Rack Mounting Kit (Part number 700293905) supports up to 8 Phone Barrier Boxes.

1. Unscrew the two screws arranged diagonally at the front of each barrier box and use these same screws to reattach the barrier box to the rack mounting strip.
2. Each barrier box is supplied with a solid green ground wire connected to its functional ground screw. Remove and discard this wire. Connect a green/yellow ground wire to the protective earth screw in the center of the Point on the back of the Barrier Box.

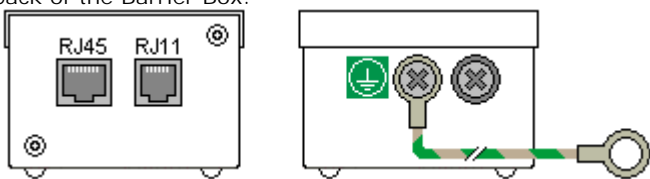

3. The rack mounting strip has threaded M4 earthing pillars. Connect the free end of the barrier box ground wire, using M4 washers and nuts, to the earthing pillar on that side of the rack mounting strip.

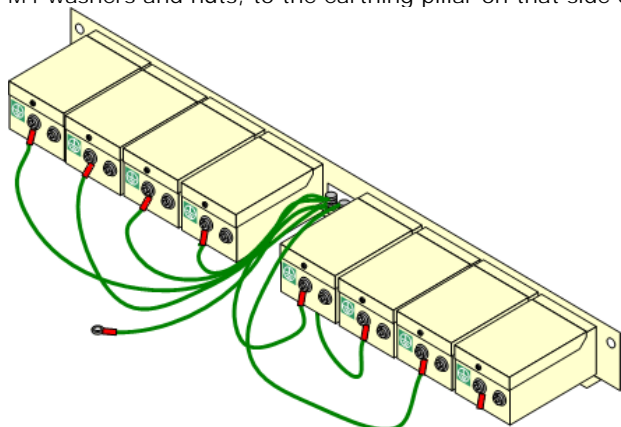

4. Using 14AWG wire with green and yellow sleeve, connect one of the earthing pillars to the buildings protective earth.

5. Using 14AWG wire with green and yellow sleeve, connect the other earthing pillar to the Phone module.

6. Ensure that the following wires are not routed together in the same bundle:

- Earth lead from the barrier box to the Phone 8/16/32.
- Internal wires, e.g. wires going directly to the Phone 8/16/32.
- Wires from external telephone going directly to the barrier boxes.

4.8 Associated Applications

This section outlines the PC applications supported by Essential Edition - PARTNER® Version. These are just outlines, for full details refer to the specific installation manuals for those applications and to the IP Office Technical Bulletins.

i Note: The use of [Windows 2000](#) operating systems is no longer tested or supported with Essential Edition - PARTNER Version applications

The following Windows applications are used to program and maintain an Essential Edition - PARTNER Version system. They run on PCs connected to the Essential Edition - PARTNER Version system via its LAN interface. These applications are all provided on the IP Office Administrator Applications CD and don't require any licenses.

Typically all these applications would be installed onto a single PC (usually a laptop) in order to ensure that each is available on site if required. Due to the nature of the applications, this should be a secure PC.

- IP Office [Manager](#)
This tool is used to access all parts of the Essential Edition - PARTNER Version configuration. Manager is also used to upgrade the software files used by the system. When running it can also act as the TFTP server from which upgradable Avaya phones can request new software.
- Embedded Voicemail
Also called Integral Voicemail, this application is supported by the IP Office 500v2 control unit. It is pre-installed on the [SD Card](#) to store messages and prompts. Embedded Voicemail supports basic voicemail mailbox operation, simple auto-attendants and hunt group announcements.
- System Status Application
This application can be used to inspect the current status of Essential Edition - PARTNER Version lines and extensions and to view records of recent alarms and events. It runs as a Java application.
- [TAPI](#)/Devlink
Provides a real-time event stream in addition to the [SMDR](#) interface provided in Essential Edition - PARTNER Version SMDR. The real-time event stream takes the form of a call record, which is issued whenever the state of any endpoint of a call changes (typically there are two end points on a call, but for some circumstances, such as conference calls or intruded calls there may be more)
- Monitor (SysMon)
Monitor is a tool that can show a trace of all activity on the Essential Edition - PARTNER Version system in detail. As a consequence, interpretation of Monitor traces requires a high-level of data and telephony protocol knowledge. Despite that however, all IP Office installers and maintainers need to understand how to run Monitor when necessary as Avaya may request copies of Monitor traces to resolve support issues.

4.8.1 Voicemail

Key features are:

- Does not require a license key.
- Maximum Message Length = 120 seconds for any message.
- Maximum of 4 Simultaneous Users
- Supports basic voicemail email and customization.
- Pin code
- Ringback
- Voicemail On/Off
- Email address
- Voicemail email on/off

User, Group and Mailbox Names

The voicemail application creates mailboxes based on the user and hunt group names allocated using the Essential Edition - PARTNER Version [Manager](#) application. Whenever either the voicemail server or the Control Unit restart, new mailboxes are created for any new names found.

This method of operation has the following consequences:

- Mailboxes are based on names: For all users and groups, if their name is changed, they may no longer be associated with their former mailbox.
- Voicemail is case sensitive: If a mailbox or start point name is entered incorrectly, the intended operation will not occur and the call may be disconnected.
- Voicemail removes spaces at the end of mailbox names: If spaces are left at the end of a mailbox user's name within Manager, when Voicemail creates the directory the space at the end of the name will be dropped. When this occurs the mailbox cannot be found as there is a miss-match between the user name and directory.

The default configuration for Essential Edition - PARTNER Version allows almost immediate voicemail operation once the voicemail server is running. The IP Office default settings are:

- Voicemail on for each user and hunt group on the IP Office.

- No Voicemail Code set for any mailboxes. Until a code is entered for a mailbox, it can only be accessed from the user's own extension.
- No Voicemail Email or Voicemail Help operational.
- No Voicemail Reception for user mailboxes.
- Whilst hunt group mailboxes are created and used by default, there is no default method for accessing them. A method for accessing each hunt group mailbox should be programmed.

A range of settings and controls are accessible through the Essential Edition - PARTNER Version [Manager](#) Application to configure the voicemail operation.

4.8.2 System Status Application (SSA)

This tool provides a wide range of information about the current status of an Essential Edition - PARTNER® system. It includes available resources and components within the system. This includes details of current call in progress. Details of the number of alarms are recorded and the time date of the most recent alarms.

When required for diagnostics escalation SSA is able to take a snap shot image of the Essential Edition - PARTNER Version system status including a copy of its current configuration. Use of SSA requires an IP Office service user name and password that has been configured for System Status access in the IP Office security settings.

Details	
DVD	IP Office Applications DVD
License	✘ No license required.

SSA is pre-installed on the system Avaya SD memory card and can be run by selecting File | Advanced | System Status from the main menu

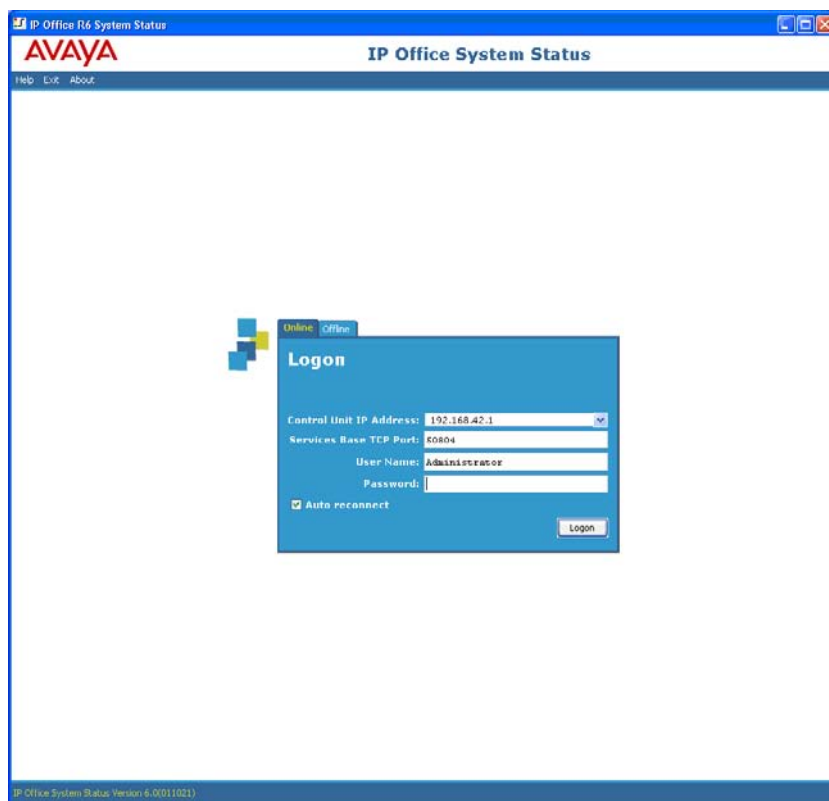

Respond to the password request.

Further SSA information is [available](#) in this document.

4.8.3 Monitor

Monitor (also know as System Monitor) is a tool that can show all activity on the Essential Edition - PARTNER Version system in great detail. As a consequence, interpretation of Monitor traces requires a high-level of data and telephony protocol knowledge. However, all IP Office installers and maintainers must understand how to run Monitor when necessary as Avaya may request copies of Monitor traces to resolve support issues.

For IP Office 4.0 and higher, the [System Status Application](#) has been added to provide more easily interpreted information than is provided by Monitor.

- Two versions of Monitor are included in the IP Office Admin applications suite, one for IP Office 4.0 systems and one for pre-4.0 IP Office systems. Care should be taken to ensure that the correct version is used when monitoring an IP Office system.

Details	
DVD	IP Office Applications DVD
Languages	English only.
License	✗ No license required.

PC Requirements

Minimum PC Requirements	
RAM	128MB
Hard Disk Free Space	10GB
Processor:	
- Pentium	PIII 800MHz
- Celeron	Celeron 3 800Mhz
- AMD	Athlon B 650MHz

Operating System Support	
Server OS:	
2003 Server	✓
2008 Server	✓
Client OS:	
XP Professional	✓
Vista	✓
Windows 7	✓

Ports

Component	Location - %ProgramFiles%\Avaya\IP Office\	Ports
System Monitor	Monitor\sysmonitor.exe	UDP 50794.

4.8.4 TAPI

IP Office TAPI is a client PC application that allows TAPI compliant applications to interact with the Essential Edition - PARTNER Version. The IP Office TAPI software can be used in one of two modes, depended on whether it is licensed or not. The same software is installed in either case with the licenses, if any, being entered in the Essential Edition - PARTNER Version system configuration.

- 3rd Party TAPI
In this licensed mode, TAPI software can be used to control call function on multiple user extension. This mode is used with CTI Developer applications.

Details	
DVD	IP Office Applications DVD
License	✗ Optional. Licenses are required for 3rd party TAPI mode operation.

 Essential Edition - PARTNER Version produces an outgoing event stream that can be processed by a third party. Avaya does not support call control itself.

PC Requirements:

Minimum PC Requirements	
RAM	64MB
Hard Disk Free Space	50MB
Processor:	
- Pentium	PIII 800MHz
- Celeron	Celeron 3 800Mhz
- AMD	Athlon B 65-0MHz

Operating System Support	
Server OS:	
2003 Server	✗
2008 Server	✗
Client OS:	
XP Professional	✓
Vista	✓
Windows 7	✗

Ports

Component	Location - %ProgramFiles%\Avaya\IP Office\	Ports
TAPI2	TAPI\tspi2w.tsp	UDP 50797.

- DevLink
Provides a real-time event stream in addition to the SMDR interface provided in Essential Edition - PARTNER Version SMDR. The real-time event stream takes the form of a call record, which is issued whenever the state of any endpoint of a call changes (typically there are two end points on a call, but for some circumstances, such as conference calls, intruded calls there may be more). Support is provided for Devlink

4.8.5 Call Logging Applications

A wide range of 3rd -party applications exist to provide call logging and accounting for telephone systems. The Essential Edition - PARTNER Version has a number of options for providing call details to those applications.

- Direct SMDR Output
The IP Office control unit can directly output SMDR records to a specified IP address.

Essential Edition - PARTNER Version has a feature Call Logs that applies to incoming outside calls when caller ID is received.

In Essential Edition - PARTNER Version, both answered and unanswered calls can be logged on a per extension basis, based on flexible configuration settings that allow logging unanswered calls arriving on specific lines at an extension, and/or logging all calls answered at the extension regardless of the line they arrive on. Every extension will have logs for its own internal answered/missed calls, and its own external answered calls. The size of the call log list for every extension is up to 30.

One extension can be designated to log all incoming outside calls, both answered and unanswered, regardless of where they terminated in the system. You can designate up to three extensions that can log all incoming outside calls, both answered and unanswered, regardless of where they terminated in the system. The size of the call log list for these three extensions is up to 400.

4.9 Physical Ports



The following port types can be found on Essential Edition - PARTNER Version systems:

Port	Found on	Description
ANALOG	ATM4 Trunk card (x4).	Used for the connection of external analog trunks.
AUDIO	Rear of IP Office control unit.	Used for input of an external music on hold source.
Digital Station	ATM4 Combination base card (x2)	Connection of Avaya digital station phones supported by IP Office
DS	Digital Station expansion modules (x16).	Connection of digital phones
RS232/DTE	All control units (x1). All expansion modules (x1).	Used for control unit maintenance under Avaya guidance. On expansion modules not used.
ETR	ETR (Enhanced Tip and Ring), provided by the ETR-6 base card.	Used for the connection of DTMF analog phone devices and Avaya ETR phones.
EXPANSION	All control units (x various). All expansion modules except WAN3 (x1).	Used for interconnection of external expansions modules and control units.
EXT O/P	All control units (x1).	Used to control external relay systems. The port provides two switchable (on, off and pulse) controls.
	All modules (x1).	Used for connection of functional or protective ground if required.
LAN	All control units (x various).	10/100Mbps Ethernet LAN ports.
PF	Analog Trunk expansion module (x2).	Analog power fails ports.
PHONE (POT)	Phones expansion modules (x8/x16).	Analog phone extension ports. On older units these ports are labeled as POT ports.
PRI	Single PRI trunk cards (x1).	PRI trunk ports.

4.9.1 ANALOG Port

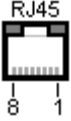
These ports are analog trunk ports. The ATM4 analog trunk cards only support loop-start trunks.

ANALOG	Pin	Description
	1	Not used.
	2	Not used.
	3	Not used.
	4	Ring.
	5	Tip.
	6	Not used.
	7	Not used.
	8	Not used.



- Off-Hook Current: 25mA.
-  **IMPORTANT**
In all IP Office installations, any module being used for analog trunk connections must be connected to a [functional earth](#).
-  **WARNING**
Within areas of high lightning risk, any module using analog trunk connections must be connected to a [protective ground](#) and to [surge protection equipment](#).

4.9.2 Audio Port

This port is found on the rear of the control unit. It is used for the input of an external music-on-hold sound source. Note that if the IP Office has loaded an internal music-on-hold sound file, any input from this socket is ignored.

The port is a 3.5mm stereo jack socket suitable for use with the most standard audio leads and connection to the 'headphone' output socket of most audio systems.

The use of a 'headphone' socket allows simple volume adjustment. Connection via a *'Line Out'* socket may require additional equipment in order to adjust the volume level.

Pin No.	Description
Common	 Common
Left	 Audio In - Left Channel.
Right	 Audio In - Right - Channel.

- Input impedance: 10k /channel. Maximum a.c. signal – 200mV rms.

4.9.3 DS Ports

These ports are used for connection from an RJ45 structured cabling system to digital station phones supported by the Essential Edition - PARTNER Version.

Though the RJ11 to RJ11 cables supplied with most DS phones can be plugged directly into RJ45 ports including those on Essential Edition - PARTNER Version modules, this is not recommend as the connection lock is not positive and may become disconnected.



DS ports on [Digital Station V2](#) expansion modules can be connected to [out-of-building extensions](#). If this is the case, connection must be made via suitable protective devices at each end and via each building primary protection. In addition the Digital Station module must be connected to a protective [ground](#).

DS ports on IP 500v2 [control units](#) must not be connected to out-of-building extensions.

Structured Cabling Line Cord

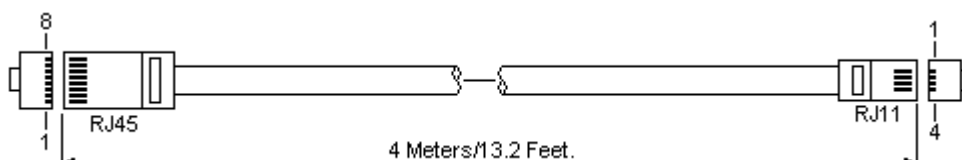
This is an RJ45 to RJ11 cable suitable for connection from a structured cabling system RJ45 port to a DS phone. It can also be used for two-wire analog phone extensions.



IP Office		Description	Phone	
DS Port	Pin		Pin	Port
	1	Not used.	–	
	2	Not used.	1	
	3	Not used.	2	
	4	Signal 1.	3	
	5	Signal 2.	4	
	6	Not used.	5	
	7	Not used.	6	
	8	Not used.	–	
Part number: 700047871				

4.9.4 ETR Port

ETR (Enhanced Tip and Ring) ports are provided by the ETR-6 base card. They can be used for the connection of DTMF analog phone devices and Avaya ETR phones.

4.9.5 Expansion Port

This type of port is found on the rear of IP 500v2 [control units](#) and external [expansion](#) modules. It is used for connecting the external expansion modules to the parent control unit.

The connection between these ports should only be done using an Avaya Expansion Interconnect Cable. No other cable type should be used.

Expansion Interconnect Cable

The Expansion Interconnect cable is used to link expansion ports between the control unit and external expansion module.

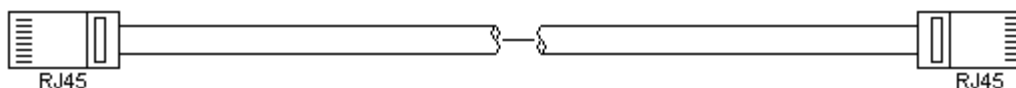

- Supply: One cable is normally supplied with each external expansion module.
- Part number: 1m (3'3") Blue cable - 700213457, 2m (6'6") Yellow cable - 700472871.

4.9.6 EXT O/P Port

The Essential Edition - PARTNER Version control unit is equipped with a EXT O/P port. The port is marked as EXT O/P and is located on the back of the control unit adjacent to the power supply input socket and uses a standard 3.5mm stereo jack plug for connection.

The port can be used to control up to two external devices such as door entry relay switches. The usual application for these switches is to activate relays on door entry systems. However, as long as the criteria for maximum current, voltage and if necessary protection are met, the switches can be used for other applications.

The IP Office is able to open (high resistance), close (low resistance) or pulse (close for 5 seconds and then open) the two switches within the port.

Door relay switches can be controlled in Essential Edition - PARTNER Version by Contact Closure 1: (Feature 41) and Contact Closure 2: (Feature 42) buttons that can be programmed onto phones using [Manager](#) or handset TUI entries.

- CAUTION: In installations where this port is connected to a device external to the building, connection must be via a towerMAX SCL/8 Surge Protector and a protective ground connection must be provided on the IP Office control unit. The towerMAX range of devices are supplied by ITWLinx (<http://www.itwlinx.com>).

EXT O/P	Pin	Description	TUI Feature
	1	Switch 1.	*41
	2	Switch 2.	*42
	3	0 Volts (Ground/Chassis)	N/A

- Switching Capacity: 0.7A.
- Maximum Voltage: 55V d.c.
- On state resistance: 0.7 ohms.
- Short circuit current: 1A.
- Reverse circuit current capacity: 1.4A.
- Ensure that pins 1 and 2 are always at a positive voltage with respect to pin 3.

3.5mm stereo audio jack plugs are frequently sold as pre-wired sealed modules. It may be necessary to use a multi-meter to determine the wiring connections from an available plug. Typically 3 (common to both relays) is the cable screen.

4.9.7 LAN Port

The IP Office control unit has 2 RJ45 Ethernet ports, marked as LAN and WAN. These form a full-duplex managed layer-3 switch. Within the IP Office configuration, the physical LAN port is LAN1, the physical WAN port is designated LAN2 but should not be used.

The LAN port LEDs indicate as follows:

- Green: On = connected, Flashing = Activity.
- Yellow: On = 100Mbps, Off = 10Mbps.

LAN Cables

These are CAT5 UTP cables for connection of various IP devices within the Essential Edition - PARTNER Version system.

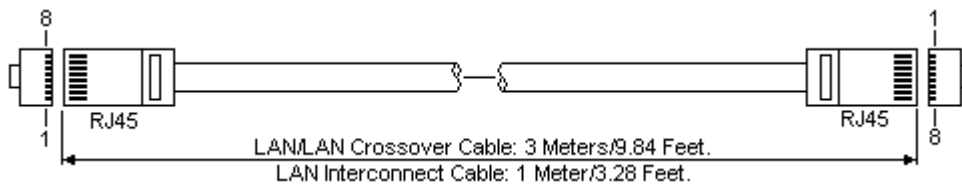

IP Office							
LAN	Pin	MDI X (Normal)	MDI (Crossover)	Wire	Standard/ Interconnect	Crossover	
	1	← Rx-A.	→ Tx-A.	White/Orange	1	3	
	2	← Rx-B.	→ Tx-B.	Orange/White	2	6	
	3	→ Tx-A.	← Rx-A.	White/Green	3	1	
	4	Not used.	Not used.	Blue/White	4	4	
	5	Not used.	Not used.	White/Blue	5	5	
	6	→ Tx-B.	← Rx-B.	Green/White	6	2	
	7	Not used.	Not used.	White/Brown	7	7	
	8	Not used.	Not used.	Brown/White	8	8	

- Part number:
 - LAN Cable - GREY: 700213481. Standard straight LAN cable.
 - LAN Crossover Cable - Black: 700213473. LAN crossover cable.

4.9.8 PF Port

These ports are analog extension ports that can be used in conjunction with analog loop-start trunks during power failure to the Essential Edition - PARTNER Version system. There are a number of options to connect analog extension ports to analog trunks during power failure. In all cases these only work with loop-start analog trunks. Any phones connected to these ports should be clearly labeled as power fail extensions in accordance with the appropriate national and local regulatory requirements.

When an IP Office 500Analog Phone 8 base card is fitted with an IP Office 500Analog Trunk daughter card, during power failure extension port 8 is connected to analog trunk port 12. The same applies to the IP Office 500ATM Combination card and the IP Office 500 [ETR-6](#) base card.

Any phones connected to these ports should be clearly labeled as power fail extensions in accordance with the appropriate national and local regulatory requirements.

PF	Pin	Description
	1	Not used.
	2	Pin 2 is internally connected to pin 5 via a ringer capacitor.
	3	Not used.
	4	Ring.
	5	Tip.
	6	Pin 6 is internally connected to pin 5 via a ringer capacitor.
	7	Not used.
	8	Not used.

- Minimum Wire Size: AWG 26.
- Maximum Cable Length:
 - AWG26: 500m / 1640'.
 - AWG24, AWG22: 1000m / 3280'.

4.9.9 Phone (POT) Port

These ports are analog extension ports. On expansion modules they can be connected to [out-of-building extensions](#). If this is the case, connection must be made via suitable protective devices (IP Office Barrier Box) at each end and via each building primary protection. In addition the Phone module must be connected to a protective [ground](#).

 PHONE ports on Essential Edition - PARTNER Version control units must not be connected to out-of-building extensions.

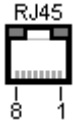
PHONE	Pin	Description
	1	Not used.
	2	Not used.
	3	Not used.
	4	Ring.
	5	Tip.
	6	Not used.
	7	Not used.
	8	Not used.

- REN: 2
- Off-Hook Current: 25mA.
- Ring Voltage: 40V rms.
- Minimum Wire Size: AWG 26.
- Maximum Cable Length:
 - AWG26: 0.5km / 1640 feet.
 - AWG24, AWG22: 1km / 3280 feet.

Except on some older equipment, these ports do not include a ringing capacitor. Therefore for connection to 4-wire analog phones where this is a requirement, connection should be via a Master socket containing ringing capacitors.

Message waiting is hard wired, 51 volt stepped

Structured Cabling Line Cord

This is an RJ45 to RJ11 cable suitable for connection from a structured cabling system RJ45 port to a DS phone. It can also be used for two-wire analog phone extensions.

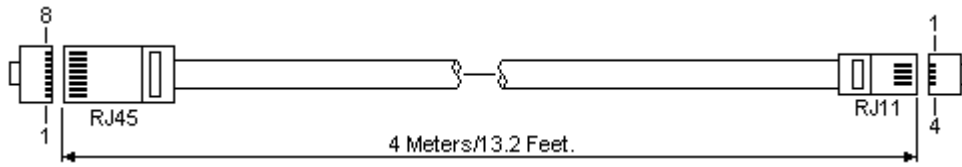

IP Office		Description	Phone	
DS Port	Pin		Pin	Port
	1	Not used.	—	
	2	Not used.	1	
	3	Not used.	2	
	4	Signal 1.	3	
	5	Signal 2.	4	
	6	Not used.	5	
	7	Not used.	6	
	8	Not used.	—	

- Part Number: 700047871.

4.9.10 PRI Port

These ports are used for connection to PRI trunk services including E1, T1 and E1-R2.

PRI Trunk Cable

This cable is used to connect from trunk ports to the line providers network termination equipment. If that equipment does not use RJ45 sockets, the cable may need to be stripped and rewired or an alternative cable used. The appropriate signal pin-outs and wire colors are detailed below.

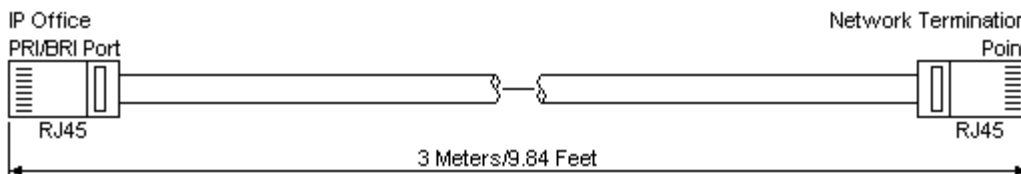

IP Office		Wire	Network Termination		
RJ45	PRI		PIN	RJ45	
	1	← Rx-A	White/Orange	1	
	2	← Rx-B	Orange/White	2	
	3	—	White/Green	3	
	4	→ Tx-A	Blue/White	4	
	5	→ Tx-B	White/Blue	5	
	6	—	Green/White	6	
	7	—	White/Brown	7	
	8	—	Brown/White	8	

- Supply: PRI trunks cards are not supplied with these cables.
- Cable Color: Red.
- Part number: 700213440.
- Standard Length: 3m/9'10".

4.9.11 RS232 DTE Port

This port is found on the rear of the control unit and external expansion modules. The DTE ports on external expansion modules are not used.

The RS232 DTE port on the control unit can be used for system maintenance and connection of serial terminal adaptors.

An asynchronous terminal program such as HyperTerminal is also required to manage the serial data exchange. Configure this for operation via a PC serial port, as follows:

Bits per second	38,400	Parity	None	Flow Control	None
Data bits	8	Stop Bits	1	PC Settings Emulation	TTY

DTE Cables

These cables are used for system maintenance and diagnostics under Avaya guidance. They can also be used for connection of RS232 serial terminal adaptor equipment to the IP Office control unit. The cable required depends on the IP Office control unit. This cable is a "Straight through DB9 female to DB9 male serial cable".

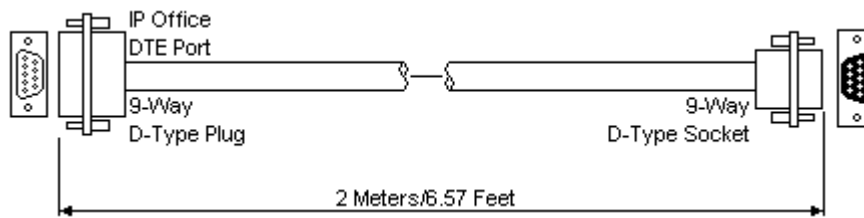

IP Office 9-Way RS232 DTE Port	Signal	PC/Terminal Adaptor
3	← Receive data	3
2	→ Transmit Data	2
7	← RTS (Request To Send)	7
8	→ CTS (Clear To Send)	8
6	→ DSR (Data Set Ready)	6
5	■ Ground	5
1	→ DCD (Data Carrier Detect)	1
4	← DTR (Data Terminal Ready)	4
9	→ RI (Ring Indicator)	9

Chapter 5.

Administration

5. Administration

This section lists the administration tasks that are involved in making any changes to the Essential Edition - PARTNER Version set-up. These actions are achieved by using IP Office [Manager](#) Essential Edition - PARTNER Version application. Please refer to the *IP Office Manager Essential Edition - PARTNER Version Admin PC Tool User Guide* for detail.

- Changes to system parameters
- Changes to users, groups and lists
- Trunk set-up
- Auxiliary equipment connection
- Auto attendant set-up
- STUN settings for networks
- Management of the SD card

5.1 Initial Configuration

This section covers basic configuration changes required for all Essential Edition - PARTNER Version systems.

- [Change the Default Passwords](#)
- [Change the System Name and IP Address /DHCP Settings](#)
- Trunk Configuration
 - [Remove Unused Trunks](#)
Disabling the use of trunks and trunk channels that are not available.
 - [Select the Clock Source for Digital Lines](#)
Altering which digital trunk is used to provide the Essential Edition - PARTNER Version with its clock signal for call synchronization.

5.2 Changing Passwords

 **WARNING** - Password Change Required

New Essential Edition - PARTNER® Version systems use default security settings. These settings must be changed to make the system secure. As a minimum, you should change the default Remote/Administrator Password if IP Office Manager Essential Edition - PARTNER Version is to be attached. Failure to do so will render the Essential Edition - PARTNER® Version system potentially unsecured.

Remote administration password

This password controls remote or local access to the Essential Edition - PARTNER Version system to make administrative changes to the overall set-up such as changes to the configuration or equipment. The administration password can only be changed by an administrator.

Change administrator password

1. From the Manager home page select Change Remote / Administration Password. A log in dialog is displayed
2. Provide login detail and enter *Administrator* (case sensitive) as your password. The change dialog is displayed.
3. Make required changes and click OK.

System Password

The system password is used to authorize overriding night service and other settings such as call barring from extension 10 or 11. If a system password is set, you must enter the system password before you can alter selected settings.

Once Essential Edition - PARTNER® Version is installed the responsibility for setting or altering this password rests with the customer.

Set or change system password using Manager

1. Click the hot link "Change System Settings"
2. In the *System Parameters* box, change system password (Field accepts digits only)

5.3 SD Card Actions

The SD Card exercises the central control of Essential Edition - PARTNER Version. There are a number of actions that can be taken as part of IP Office administration as follows:

- Shutdown and [start-up](#) an SD card
- Format an SD card
- Read, write and delete files on an SD card
- Copy/Recreate an SD card
- [Backup](#) an SD card

 SD card administration tasks through phone handset # (TUI) codes differ slightly in scope. Refer to the *Essential Edition - PARTNER Version Phone Admin Guide* for details.

5.3.1 Removing SD Cards

SD Card Removal

SD cards should never be removed while being used. Though the SD card slot LEDs indicate when data is being written to an SD card, lack of flashing LED is not a sufficient safeguard. The IP Office Manager provides methods to [shutdown and restart an individual card](#) or to [shutdown the](#) Essential Edition - PARTNER Version system in order to allow removal of an SD card. If the System SD card is removed, licensed features will continue operating for up to 2 hours.

5.3.1.1 Card Shutdown

Before a memory card is removed from an Essential Edition - PARTNER Version system that is running, the card should be shutdown. Removing a memory card while the system is running may cause file corruption.

Shutting down the memory card disables all services provided by the card including embedded voicemail. Features licensed by the memory card will continue to operate for up to 2 hours.

Card services can be restarted by either reinserting the card or using a Start Up command.

Card Shutdown Using Manager

1. Using IP Office Manager, select File | Advanced | Memory Card Commands | Shutdown.
2. In the Select IP Office dialog, select the IP Office system containing the memory card.
3. Click OK.
4. At the back of the control unit, confirm that the memory card LED is off.
5. The card can now be removed in order to perform the necessary maintenance actions.

SD Card Removal

SD cards should never be removed while being used. Though the SD card slot LEDs indicate when data is being written to an SD card, lack of flashing LED is not a sufficient safeguard. The IP Office Manager provides methods to [shutdown and restart an individual card](#) or to [shutdown the](#) Essential Edition - PARTNER Version system in order to allow removal of an SD card. If the System SD card is removed, licensed features will continue operating for up to 2 hours.

5.3.1.2 Card Startup

Reinserting a card into a system that is already switched on will automatically restart the card. Similarly reinserting the card and rebooting the Essential Edition - PARTNER Version system will restart the card. However, if the card has been shutdown but not removed, it can be restarted using Manager without requiring a reboot.

Card Startup Using Manager

1. Using IP Office Manager, select File | Advanced | Memory Card Commands | Startup.
2. Using the Select IP Office menu, select the IP Office system containing the memory card.

3. Click OK.

 After reinsertion, the SD card may not be fully functional until two hours have elapsed.

5.3.2 Directories and Files

The System SD card contains the following folders:

System SD

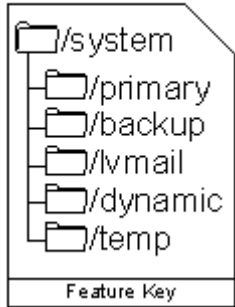

- primary
Contains the firmware files for the Essential Edition - PARTNER Version control unit, external expansion modules and supported phones. The folder can also contain music on hold files and license key files. This is the main set of files used by the Essential Edition - PARTNER Version system when booting up. Also contains the stored copy of the system configuration.
- backup
Contains a copy of the primary folder at some previous point. A backup copy of the primary contents to this folder can be invoked manually (using Manager or SSA) or as part of the IP Office software upgrade using Manager.
- lvmail
Contains the prompts used by embedded voicemail and the mailbox messages.
- dynamic
Contains files used by the IP Office and retained through a reboot of the Essential Edition - PARTNER Version system.
- temp
Contains temporary files used by the IP Office and not retained through a reboot of the Essential Edition - PARTNER Version system.

The Optional SD card can contain a similar set of folders. These are used as an additional backup or they can be used as the source for upgrading the contents of the System SD card.

Files present on an SD system card can be classified into three differing types:

1. Fixed System files – files essential for system operation that are fixed in name and/or location
2. Dynamic System files – files essential for system operation that are dynamic in nature (e.g. voice messages, Sysmon and [SMDR](#) buffer logs)
3. Non system files – all others

Fixed system files comprise:

- IP Office 500 firmware binary
- Expansion binaries
- All current DCP phone binaries
- All current IP phone binaries
- ADMM base station binary
- Embedded voicemail prompts
- Embedded AA clips
- System configuration
- DHCP allocation
- Call logs
- Music On Hold (Not yet implemented)
- License merge

Fixed System Files only exist in two directories: '`\system\primary`' and '`\system\backup`'. Some fixed system files must be specifically named. They have the system and read-only file attributes set to reduce inadvertent deletion/modification

Dynamic system files comprise:

- Embedded voicemail recordings
- Sysmon logs
- SMDR buffer logs

Dynamic system files only exist in one directory: '`\system\dynamic`' and are usually dynamically named. They have the system file attribute set to reduce inadvertent deletion.

Non system files can be any type, including copies of any of the above – it is the directory and name that determine the type of file.

5.3.3 Booting from the SD Cards

System SD

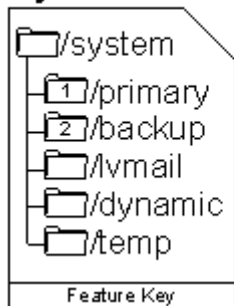

Optional SD

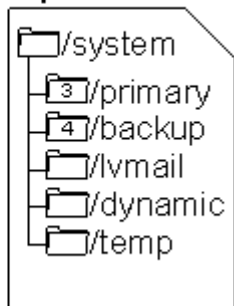

During power up, Essential Edition - PARTNER Version looks for valid firmware to load into memory in the following order.

1. System SD card primary folder.
2. System SD card backup folder.
3. Optional SD card primary folder.
4. Optional SD card backup folder.
5. BootP request to IP Office Manager.

The control unit can be forced to bypass the primary folder by pressing the Aux switch on the rear panel when applying power to the control unit.

5.3.4 SD Card Removal

Before a memory card is removed from an Essential Edition - PARTNER Version system that is running, the card should be shutdown. Removing a memory card while the system is running may cause file corruption.

Shutting down the memory card disables all services provided by the card including embedded voicemail. Features licensed by the memory card will continue to operate for up to 2 hours.

Card services can be restarted by either reinserting the card or using a Start Up command.

Card Shutdown Using Manager

1. Using IP Office Manager, select File | Advanced | Memory Card Commands | Shutdown.
2. In the Select IP Office dialog, select the IP Office system containing the memory card.
3. Click OK.
4. At the back of the control unit, confirm that the memory card LED is off.
5. The card can now be removed in order to perform the necessary maintenance actions.

Card Reinsertion

Reinserting a card into a system that is already switched on will automatically restart the card. Similarly reinserting the card and rebooting the Essential Edition - PARTNER Version system will restart the card. However, if the card has been shutdown but not removed, it can be restarted using Manager without requiring a reboot.

Card Startup Using Manager

1. Using IP Office Manager, select File | Advanced | Memory Card Commands | Startup.
2. Using the Select IP Office menu, select the IP Office system containing the memory card.
3. Click OK.



If the SD card is removed, license information is retained for approximately two hours, thus allowing Essential Edition - PARTNER Version to continue operation.

When a card is subsequently reinserted the control unit may not function correctly for the first two hours.

5.3.5 Recreating an IP Office SD Card

The new card must be correctly formatted because, for the System SD slot only Avaya SD cards with a Feature Key should be used.

⚠ WARNING

Avaya supplied SD cards should not be formatted using any other method than the format commands within Essential Edition - PARTNER Version Manager and Essential Edition - PARTNER Version system Status Application. Formatting the cards using any other method will remove the feature key used for IP Office licensing from the card.

Note: This task requires a PC with an SD card read/write drive attached and IP Office Manager Essential Edition - PARTNER Version software installed

i Only this method should be used for formatting an Avaya SD card. Using IP Office Essential Edition - PARTNER Version Manager ensures that special files required for Essential Edition - PARTNER Version operation are created and that the Feature Key information is retained.

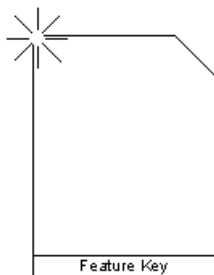

- ⚠ WARNING: All File Will Be Erased**
Note that this action will erase any existing files and folders on the card. Once a card has been formatted, the folders and files required for Essential Edition - PARTNER Version operation can be loaded onto the card from the Manager PC using the Recreate IP Office SD Card command.
 1. Insert the SD card into a reader slot on the Manager computer.
 2. From Manager main menu, select File | Advanced | Format IP Office SD Card.
 3. Select IP Office Partner Version. This selection just sets the card label shown when viewing the card details. It does not affect the actual formatting. Select the label that matches the files set you will be placing on the card.
 4. Browse to the card location and click OK.
 5. The status bar at the bottom of Manager displays the progress of the formatting process.
 6. When the formatting is complete, you can use the Recreate IP Office SD Card command to load the IP Office folders and files onto the card from the Manager PC.

Format rules: SDHC minimum 4GB FAT32 format (Single partition, SDHC, class2+, FAT32, SPI & SD bus).

Writing an IP Office SD Card

This process will create the folder structure on the SD card and copy the necessary firmware files from those installed with Manager onto the SD card. This includes the binary files for the IP Office 500v2 system, any external expansion modules and phones. It also includes the prompt files for embedded voicemail operation.

This process can be used to upgrade an existing SD card to match the file set installed with Manager. For the card to be used in an IP Office 500v2 system System SD slot the card must be Avaya SD Feature Key card. The card must be correctly formatted (see Format IP Office SD card).

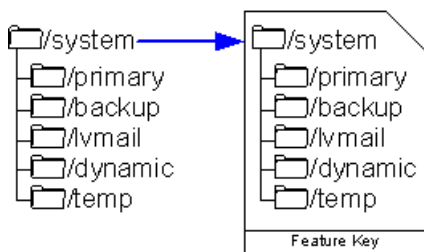

1. Note: This process can take up to 20 minutes depending on the PC. Once started it is recommended that the process is not interrupted.
2. Insert the SD card into a reader slot on the Manager computer.
3. Using Manager, select File | Advanced | Recreate IP Office SD Card.
4. Select IP Office Partner Version. This selection will affect how the Essential Edition - PARTNER Version system operates when defaulted with this card present in its System SD card slot. .
5. Browse to the card location and click OK.
6. Manager starts creating folders on the SD card and copying the required files into those folders.

5.3.6 Backing Up the System SD Card

There are two levels of backup that can be performed.

- [Backup the System SD Card Primary Folder](#)
The contents of the primary folder on the card can be copied to the backup folder. They files can then be restored if necessary. Both actions can be performed remotely.
- [Backup the Whole System SD Card](#)
The contents of the whole System SD card can be copied to the Optional SD card. While this can be done remotely, the contents can only be copied back manually using an SD card reader.

i Note that in either case, the configuration file on the System SD card will not contain any changes made by IP Office users since the last overnight backup or the last system shutdown.

5.3.6.1 Backup the System Primary Folder

System SD

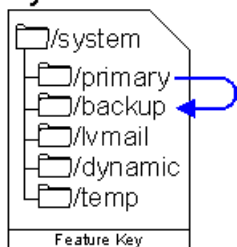

This process copies the contents of the primary folder on the System SD card over the backup folder. Any files with matching file names will be replaced.

Backing up the primary folder to the backup folder using Manager

1. Using Manager main menu, select File | Advanced | Embedded File Management.
2. From the Select IP Office dialog, tick the box beside the Essential Edition - PARTNER Version system you want to work with.
3. The file contents of the memory cards are displayed.
4. Select File | Backup System Files.
5. The contents of the primary folder on the System SD card are copied to the backup folder.

Backing up the primary folder to the backup folder using telephone handset

1. Press the Feature button .
2. Dial #124.
3. The contents of the primary folder on the System SD card are copied to the backup folder.
4. Press the Feature button.

5.3.6.2 Restore from the System Backup Folder

System SD

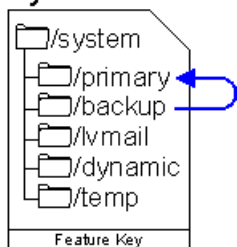

This process copies the contents of the backup folder on the System SD card over the primary folder. Any files with matching file names will be replaced.

To make the restored files active the IP Office system then needs to be restarted using a [reboot](#).

Restoring the system backup folder to the primary using Manager

1. Using Manager main menu, select File | Advanced | Embedded File Management.
2. From the Select IP Office dialog, tick the box beside the Essential Edition - PARTNER Version system you want to work with.
3. The file contents of the memory cards are displayed.
4. Select File | Backup System Files.
5. The contents of the primary folder on the System SD card will be copied to the backup folder.

5.3.6.3 Copying the System Card to the Optional Card

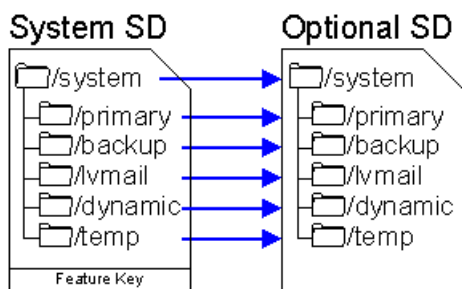

This process copies all files on the System [SD](#) card to the Optional SD card. It includes the primary and backup folders and the embedded voicemail files including message files.

Any matching files and folders on the Optional SD card are overwritten.

There is no in-built method for copying the contents of an Optional SD card back onto a System SD card. If that is necessary it must be done by [removing the cards](#) and copying files using a PC with a SDHC compatible card reader.

Copying the system card to the optional card using Manager

1. Using Manager main menu, select File | Advanced | Embedded File Management.
2. From the Select IP Office dialog, tick the box beside the Essential Edition - PARTNER Version system you want to work with.
3. The file contents of the memory cards are displayed.
4. Select File | Copy System Card.
5. The contents of the System SD card are copied to the Optional SD card.

5.4 External Trunk Configuration

This section cover the basic requirements for external trunk configuration. The exact method of physical connection and configuration will vary with each trunk provider and so requires local telecoms experience. The topics covered here are general guidelines.

- [Clock Quality](#)
Altering which digital trunk is used to provide the IP Office with its clock signal for call synchronization.
- [Unused Trunks](#)
Disabling the use of trunks and trunk channels that are not available.

Refer to the *IP Office Essential Edition - PARTNER Version Admin PC Tool (Manager) User Guide* or the *IP Office Essential Edition - PARTNER Version Phone Administration Guide (TUI)*.

5.4.1 Clock Quality

Any system where digital trunks are being used requires a clock signal for call synchronization between the switches at each end of the trunk. Typically the clock signal provided by a digital trunk from the central office exchange is the best quality and most reliable source.

The Essential Edition - PARTNER Version can obtain and use the clock signal from any of its digital trunks. However it will only use one trunk for its clock signal at any time and will ignore any other possible clock sources. If no clock source is available the Essential Edition - PARTNER Version can use its own internal clock if necessary.

The Clock Quality setting on each line is set to one of the following:

- *Network*
If available, the clock signal from this trunk can be used as the Essential Edition - PARTNER Version clock source.
- *Fallback*
If available, the clock signal from this trunk can be used as the clock source only if none of the trunks set to Network are providing a clock source.
- *Unsuitable*
The clock source from this trunk is never used as the IP Office clock source.

In the example below the first Essential Edition - PARTNER Version is set to use the public network trunk as its clock source and ignoring the possible clock source from the QSIG trunk. However the other system is using the QSIG trunk as it clock source.

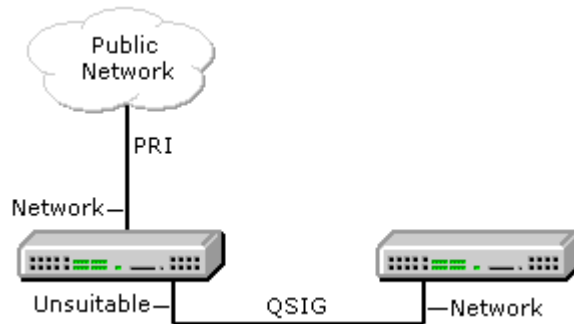

Source Priority

When multiple trunks with the same setting are providing a clock signal, the trunk used is determined in the following order of slots 1 to 4 and then by port on each slot.

Viewing the Current Clock Source

The current clock source being used by an Essential Edition - PARTNER Version system is shown on the Resources page within the IP Office [System Status Application](#).

 Objective - Set a chosen digital trunk as the network clock source and set all other digital trunks as fallback or unsuitable.

Refer to the *IP Office Essential Edition - PARTNER Version Admin PC Tool (Manager) User Guide* or the *IP Office Essential Edition - PARTNER Version Phone Administration Guide (TUI)*.

5.4.2 Unused Trunks

Each IP Office trunk card provides a fixed number of trunk ports. For digital trunks each trunk provides a set number of digital channels. In cases where the number of trunks connected to the Essential Edition - PARTNER Version is lower or the number of channels provided is lower, those unused trunks and channel must be disabled.

-  Failure to do this will cause problems with outgoing calls. For example, on a system with an ATM4 trunk card fitted but only two analog trunks actually connected, failure to disable the other two trunks within the Essential Edition - PARTNER Version configuration will cause 50% of outgoing call attempts to fail.

 Objective

Remove unused trunks and channels from the telephone system configuration.

Refer to the *IP Office Essential Edition - PARTNER Version Admin PC Tool (Manager) User Guide* or the *IP Office Essential Edition - PARTNER Version Phone Administration Guide (TUI)*.

5.5 Changing Components

Base cards and external expansions modules must only be removed and added to an Essential Edition - PARTNER Version system when that system is switched off.

In the sections below, the term component can refer to a card fitted into the control unit or an external expansion module.

 Note that for extension ports, by default both an extension entry and a user entry will exist in the Essential Edition - PARTNER Version configuration. Extension entries can be deleted without deleting the corresponding user entry. This allows retention of the user settings and association of the user with a different extension by changing the extensions Base Extension number to match the user's Extension ID.

Like for Like Replacement

If replacing with a component of the same type no configuration changes are necessary.

1. Switch off the Essential Edition - PARTNER Version system.
2. Remove the card or external expansion module. Note the card slot or expansion port used as the replacement must be installed in the same position.
3. Install the replacement using the appropriate process for the type of component ([Fitting IP Office 500 cards](#)).
4. Restart the Essential Edition - PARTNER Version system.

Higher Capacity Replacement

If replacing with a component of the same type but higher capacity, when restarted the IP Office will automatically create configuration entries for the new trunks or extensions/users.

1. Switch off the Essential Edition - PARTNER Version system..
2. Remove the card or external expansion module. Note the card slot or expansion port used as the replacement must be installed in the same position.
3. Install the replacement using the appropriate process for the type of component ([Fitting IP Office 500 cards](#)).
4. Restart the Essential Edition - PARTNER Version system.
5. Use [Manager](#) to configure the new trunks or extensions/users.

Lower Capacity Replacement

If replacing with a component of the same type but lower capacity, after restarting the IP Office the configuration will need to be edited to remove redundant entries.

1. Switch off the Essential Edition - PARTNER Version system..
2. Remove the card or external expansion module. Note the card slot or expansion port used as the replacement must be installed in the same position.
3. Install the replacement using the appropriate process for the type of component ([Fitting IP Office 500 cards](#)).
4. Restart the Essential Edition - PARTNER Version system.
5. Use Manager to delete the trunks or extensions/users in the configuration that are no longer supported by the component installed.

Adding a New Component

If adding a new component to an available slot or port, when restarted the IP Office will automatically create configuration entries for the new trunks or extensions/users.

1. Switch off the Essential Edition - PARTNER Version system..
2. Install the replacement using the appropriate process for the type of component ([Fitting IP Office 500 cards](#)).
3. Restart the Essential Edition - PARTNER Version system.
4. Use Manager to configure the new trunks or extensions/users.

Permanent Removal

If permanently removing the component, the configuration will need to be edited to remove redundant trunk or extension/user entries.

1. Switch off the Essential Edition - PARTNER Version system.
2. Remove the card or external expansion module.
3. Restart the Essential Edition - PARTNER Version system.
4. Use Manager to delete the trunks or extensions/users in the configuration that relate to the component removed.
5. In the Control Unit section of the configuration, delete the entry for the component that is no longer present in the system.

Replacement of a Different Type

If replacing a component with one of a different type, the process should be divided into two stages. First remove the existing component using the Permanent Removal process above and adjust the configuration and reboot. Then install the new component using the Adding a New Component process above.

System - License Management

Key	Type	Status	Quantity	Expiry Date
<New>	Invalid	Invalid	0	0/0/0

This dialog is reached by selecting System | License Management from the [Manager Admin Tasks](#) pane. It is used to enter licenses required for additional telephone system features. For example licenses are used to enable additional voicemail ports or the twinning feature.

- **Import**
Import licenses from a CSV file. Each line of the file should contain a license name and the 32-character license key, each separated by a comma.
- **Export**
Export the licenses to a CSV file. (Only if exportable licenses are present on the system)

For each license key entered, the following information is displayed:

- **Key**
This is the 32-character license string.
- **Type:** *Information field, not editable.*
If the Key is recognized, the name of the feature it licenses is shown in this field. If *Invalid* is displayed it indicates that the Key has not been correctly entered.
- **Status:**
This field shows the status of the license.
 - *Unknown* is shown for newly entered licenses until the configuration is sent to the phone system and then reloaded again.
 - *Valid* is shown if the license key matches the SD card serial number.
 - *Invalid* is shown if the license key does not match the [SD card](#) serial number.
 - *Dormant* is shown if the license key is valid but is conditional on another license that is not present.
 - *Obsolete* is shown if the license key is valid but the license is no longer used by the version of software installed in the phone system.
- **Quantity:** *Information field, not editable.*
This field indicates how many items are enabled by the license. The meaning of this will vary depending on the feature being licensed.
- **Expiry Date:** *Information field, not editable.*
Some licenses have an expiry date. This field will indicate that date.

5.7 Additional Processes

5.7.1 Upgrading the System

Upgrade is performed using the Upgrade Wizard tool within the IP Office [Manager](#) Essential Edition - PARTNER Version application (File | Advanced | Upgrade). It displays the systems it can detect, their existing software level and the levels it has available.

- **Check IP Office Technical Bulletins**
Whenever upgrading check the latest IP Office Technical Bulletins for the various IP Office software releases involved before proceeding. These may contain information relating to changes that occurred after this document was completed. Bulletins are available from <http://support.avaya.com>.

- **Multi-Stage Upgrades**
The upgrade path may require several intermediate upgrades. Skipping an intermediate level may lead to incorrect system operation and configuration corruption. Multi-stage upgrades are only necessary for control units. External expansion modules can be upgraded directly between any two levels supported by the module.

There are two methods that the IP Office may use for upgrading, these are Validated, and Non validated.

- **Validated Upgrade**
This is the preferred method and can be used with any IP Office system that already has IP Office software. By default the Validate option within the Upgrade Wizard is pre-selected. During this process, the required BIN files are first transferred to the IP Office RAM memory. Only when the files are received will the IP Office overwrite the existing software in its Flash memory and restart using the new files.
- **Non validated Upgrade**
This is the least preferred upgrade method. It should only be used from a PC directly connected to the IP Office and with a fixed IP address on the same LAN domain as the IP Office LAN1. This method involves erasing the existing software in the IP Office Flash memory and then copying the new BIN files directly to the Flash memory. Its uses BOOTP and TFTP and requires a BOOTP entry for the IP Office system to exist on the Manager PC. This method should not be used unless absolutely necessary.

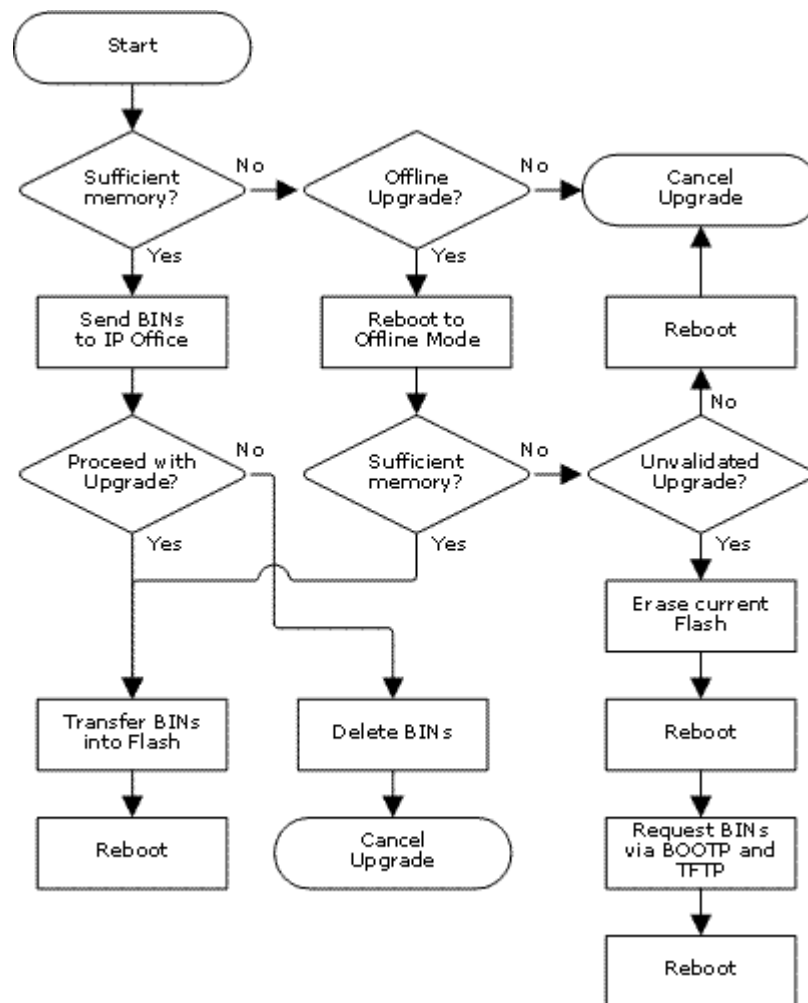

Upgrade Process

5.7.2 Upgrading the Core Software

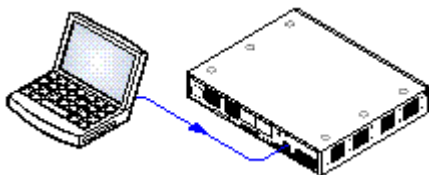

 Objective - Upgrade the control unit to IP Office software.

 Information Required

- Remote/Administrator Password - For a new or defaulted system this is *Administrator*.

 Tools Required

- Manager PC - The Upgrade Wizard tool is part of the Manager application.

WARNINGS

- Check IP Office Technical Bulletins
Check the latest IP Office Technical Bulletin for the IP Office software release before proceeding any further. It may contain information relating to changes that occurred after this document was completed. Bulletins are available from <http://support.avaya.com>.
- Multiple Managers
If more than one copy of Manager is running it is possible for the Essential Edition - PARTNER Version to request BIN files from a different Manager than the one that started the upgrade process. Ensure that only one copy of Manager is running when upgrading an Essential Edition - PARTNER Version system.



Procedure: Upgrade Procedure

1. Using Manager, click  and receive the configuration from the Essential Edition - PARTNER Version. If not already done this action creates a BOOTP entry in Manager for the IP Office system and displays a Essential Edition - PARTNER Version admin tool screen. This action also confirms communication between the Manager PC and the Essential Edition - PARTNER Version.
2. Select File | Save Configuration As... and save a copy of the configuration file onto the PC. This action should be completed before upgrading any IP Office system.
3. Select File | Advanced | Upgrade.
4. The Upgrade Wizard is started and scans for IP Office unit, using the Unit/Broadcast address. Adjust this address and click Refresh if the expected modules are not shown.
5. For each unit found, the Upgrade Wiz displays the module type, its current version of software installed in the unit and the software version of the .bin file that Manager has available.
6. For those units and modules where manager detects that it has a higher version available, the tick box next to the unit or module is automatically selected.
7. For those modules which you want to upgrade, tick the check box. For modules where a later version of software is available the check box may have already been automatically ticked.
8. Select Upgrade.
9. The system password is requested. Enter it and click OK.
10. The .bin files required are transferred to the system and stored in temporary memory.
11. Once all the files have been transferred, the upgrade wizard will prompt whether it okay to proceed with the upgrade process. Select Yes to continue.
12. Each module being upgraded will delete its existing core software, restart and load the new software file that was transferred. This process may take several minutes for each unit. Do not cancel or close the upgrade wizard while this process is running.
13. Following the upgrade check that the upgrade wizard now shows that the selected units and modules have upgraded. It may be necessary to select Refresh to update the information in the upgrade wizard display.

5.7.3 Changing the IP Address Settings

By default the IP Office system name is set to match its MAC address. This can be changed to something more distinctive.

When a new or defaulted Essential Edition - PARTNER Version is switched on, the control unit makes a DHCP requests for IP address settings on its LAN interface.

- If the IP Office receives a response from a DHCP server, it configures itself as a DHCP client using the address details provided by the DHCP server.
- If the IP Office does not receive a response from a DHCP server, it will configure itself as a DHCP server and use the following default address details:

Network Settings	LAN1	LAN2/WAN
IP address	192.168.42.1.	192.168.43.1
IP Mask	255.255.255.0	255.255.255.0
DHCP Mode	Server	Server
No of DHCP IP Addresses	200.	200.

If the IP address and DHCP mode settings are not suitable for the customers network then they should be changed. Note that changing the IP Office IP address settings requires it to restart.

1. [Connect](#) to the Essential Edition - PARTNER Version system and start IP Office [Manager](#).
2. In the home page, click Change System Settings.
3. In the System Parameters area Name field, enter a distinctive name for the IP Office system..
4. Make sure the *Receive IP Address Via DHCP Server* box is not checked.
5. Change the IP Address, Sub-Net Mask and Default Gateway settings to match the customer requirements.
6. Click Apply.
7. Click the save icon  in the menu bar to save the updated configuration back to the IP Office system.
8. After the IP Office has restarted, unless the Manager PC is using a DHCP client address, change the PC address to match.

5.7.4 System Shutdown

IP Office can be shut down in order to perform maintenance. The shut down can be either indefinite or for a set period of time after which the IP Office will automatically reboot.

During the shut down process, the current configuration in the control unit RAM memory is copied to the control units non-volatile memory.

The SD memory card can be [shutdown and restarted](#) separately from the system.

-  **WARNING**
When shutdown the system cannot be used to make or receive any calls. This is not a polite shutdown, any users calls and services in operation will be stopped.

System Shutdown Using Manager

1. Using IP Office Manager, select File | Advanced | System Shutdown.
2. Using the Select IP Office menu, select the system to be shutdown by activating its checkbox.
3. You will be prompted for log in details
4. Select the shutdown mode. If Indefinite is used, the system can only be restarted by having its power switched off and then on again. If a Timed shutdown is selected, the IP Office will reboot after the set time has elapsed.

System Shutdown Using System Status

1. Start [System Status](#) and access the status output of IP Office.
2. In the navigation panel select System.
3. At the bottom of the screen select Shutdown System.
4. Select the time duration for the shutdown or indefinite.

System Shutdown Using a System Phone

This process can be used by any user configured as a System Phone user and using a 1400 Series phone. The user's Login Code is used to restrict access to system administration functions on the phone.

Unlike Manager, a system phone user cannot select an indefinite shutdown. The can set a timed shut down of between 5 minutes and 24 hours.

1. Select Features | Phone User | System Admin.
2. From the menu select System Shutdown.
3. Select a time period for the shutdown. It must be in between 5 minutes and 24 hours.
4. Press Done and then Confirm to begin the shutdown.

5.7.5 Rebooting the System

You can use IP Office Manager to reboot an IP Office system.

1.
2.
3.

1. Using IP Office Manager, select File | Advanced | Reboot.
2. From the Select IP Office menu, locate and select the Essential Edition - PARTNER Version system you want to reboot.
3. Click OK. You are prompted to enter a valid user name and password.
4. The type of reboot can then be selected.

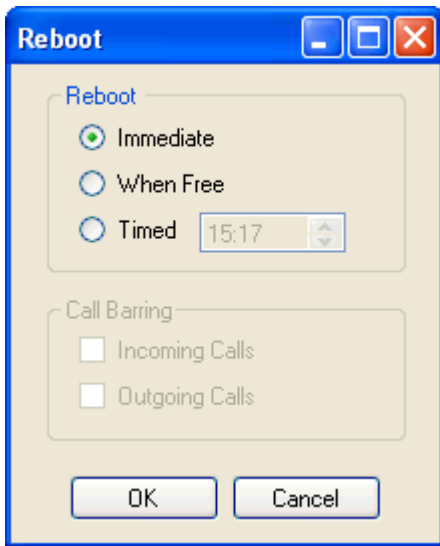

- Reboot
Select when the reboot should occur.
 - Immediate
Send the configuration and then reboot the IP Office.
 - When Free
Send the configuration and reboot the IP Office when there are no calls in progress. This mode can be combined with the Call Barring options.
 - Timed
The same as When Free but waits for a specific time after which it then wait for there to be no calls in progress. The time is specified by the Reboot Time. This mode can be combined with the Call Barring options.
- Reboot Time
This setting is used when the reboot mode Timed is selected. It sets the time for the IP Office reboot. If the time is after midnight, the IP Office normal daily backup is canceled.
- Call Barring
These settings can be used when the reboot mode When Free is selected. They bar the sending or receiving of any new calls during reboot.

4. Click OK.

Chapter 6.

Troubleshooting

6. Troubleshooting

Problem...	Check this...
Laptop does not seem to communicate with the control unit	<ol style="list-style-type: none"> 1. The default address for an IP Office Essential Edition - PARTNER Version control unit LAN port is 192.168.42.1/255.255.255.0. If required (should not be necessary), change the TCP/IP properties for the PC LAN port to the following: <ul style="list-style-type: none"> Fixed IP address 192.168.42.203 Subnet mask 255.255.255.0 Default gateway 192.168.42.1. 2. Connect the LAN cable from the PC LAN port the LAN port on the IP Office control unit. 3. Check that the orange LED lamp on the IP Office LAN port is on. The green LED may also be flickering as it indicates traffic across the LAN connection. 4. To test the connection before running Manager or System Status Application: <ul style="list-style-type: none"> • Select Start Run and enter <i>cmd</i>. • In the command window that appears enter ping 192.168.42.1. The results should show a number of ping replies from the IP Office. This confirms basic communication between the Manager PC and the IP Office. • If there are no ping replies enter ipconfig. The results should list the IP address settings of the Manager PC as required above. If they do enter exit and check the cable connection.
Telephone does not ring	<p>Ringer volume may be too low. Do Not Disturb or Call Forwarding may be turned on. Line Ringing may not be set to Immediate. Telephone may be faulty; switch telephones and try again.</p>
Display shows only 16 characters per line	Possible power outage; unplug the modular telephone cord and re plug.
Display time and date are not correct	Is your system clock correct? Set system time and date
Caller ID does not work	Are you subscribed to Caller ID? Is the line connected to a module that supports Caller ID? Did someone activate Call Coverage? If so, their extension number will appear.
Telephone does not Work	Is the telephone cord plugged into the correct jack on the bottom of the telephone? Telephone may need to be reset; unplug the cord, and with the handset hung up, re plug. Telephone cord may be defective; switch cords and try again. Telephone may be defective; switch telephones and try again. There may be a problem with the control unit; switch to a different port and try again.
Intercom Autodialer does not work	Is the telephone cord plugged into the right jack of the DSS? Is the Intercom Autodialer plugged into an electric outlet? Telephone cord may be defective; switch cords and try again.
Cannot record a call	Two calls may already be recording. Make sure you have a four-port mail system. You may not have enough ports programmed in Hunt Group.
Standard phone message waiting light does not light	The message waiting light may not be compatible with the system; only phones with LEDs, not neon lights, support message waiting lights. Or, the telephone may not be connected to the proper module.
Cannot make outside calls	Is Forced Account Code Entry assigned to this extension? Is your dial mode (touch-tone or rotary) incorrect? Use Dial Mode (#201) to reset it. Has someone changed the Outgoing Call Restriction for the extension? Did someone lock the extension with Station Lock? Use Station Unlock from extension 10 or 11 to unlock it. Local telephone company may not be receiving signals accurately. If problem is on just one telephone, see "Telephone does not Work" above. Too many tip/ring devices may be trying to dial at once. Local telephone company line may be faulty; unplug each line from its module and test it by using a single-line telephone: <ul style="list-style-type: none"> • If the trouble does not occur on the single-line telephone, the problem is in your control unit.

Problem...	Check this...
	<ul style="list-style-type: none"> • If the trouble occurs on the single-line telephone, switch the line cord and try again. If this does not work, call the telephone company.
Cannot make outside calls from pool buttons on pooled extensions	<p>Is Forced Account Code Entry assigned to this extension? Is your dial mode (touch-tone or rotary) incorrect? Use Dial Mode (#201) to reset it. Has someone changed the Pool Access Restriction for the extension? Pool may not be assigned to the extension. There may not be enough lines assigned to the pool to support the usage. One or more local telephone company lines may be faulty; test each line from extension 10.</p>
Auxiliary device does not answer	<p>Device may not recognize the system ringing pattern:</p> <ul style="list-style-type: none"> • Change the extension ring pattern by using Distinctive Ring (#308). • Change the setting for Intercom Dial Tone (#309) to Machine; the system will generate an outside dial tone for the extension.
Trouble hearing the person you called	<p>If you are using a speakerphone, try using the handset. If you have touch-tone dialing, you may have a faulty telephone or cord.</p>
Automatically dialed calls beginning with star codes are miss dialed	<p>Setting may not be inserting a long enough pause; increase setting. Recall feature is not working. Increase Recall Timer Duration (#107) by 100 milliseconds. If using the feature disconnects the call, decrease Recall Timer Duration by 100 milliseconds.</p>
Calls on hold are disconnected	<p>CO Disconnect Time (#203) setting may be too short.</p>
Call on Hold hangs up, but line does not disconnect	<p>CO Disconnect Time (#203) may be too long; try resetting it. Local telephone company does not send a hold release signal; you may need the help of our hotline.</p>
All telephones dead; no dial tone or lights	<p>Power may have been interrupted to the control unit; check the power cord, the on/off switch, and the LEDs on the modules. Power outlet may be faulty; test the outlet with an appliance like a lamp.</p>
Multiple telephones dead; no dial tone or lights	<p>one or more system modules may be out; try reseating the module in the control unit.</p>



Chapter 7.

Appendices

7. Appendices

This appendix section contains supplementary information.

7.1 Safety Statements

7.1.1 Lightning Protection/Hazard Symbols

Lightning protectors

The buildings lightning protectors must be verified as follow:

1. Check the lightning protectors, at the trunk cable entry point to the building housing the Avaya IP Office, paying special attention to the lightning protection grounding. Report any problems, in writing, to the telephone company.
2. Equipment that is designed to be connected using internal wiring is typically not lightning protected. Hence, Avaya IP Office extension cabling must not leave the building. For installations where telephones and/or other standard (tip/ring) devices are installed in another building then lightning protection is required (see [Out of Building Telephone Installations](#)).

Hazard Symbol



- The shock hazard symbol is intended to alert personnel to electrical hazard or equipment damage. The following precautions must also be observed when installing telephone equipment:
 2. Never install telephone wiring during a lightning storm.
 3. Never install telephone jacks in wet locations unless the jack is specifically designed for wet locations.
 4. Never touch uninsulated telephone wires or terminals unless the telephone line has been disconnected at the network interface.
 5. Always use caution when working with telephone lines.

7.1.2 Trunk Interface Modules

To ensure the validation of the approvals, only the following types of trunk interface cards must be fitted in the following IP Office control units.

USA/Canada				
Product	PRI E1	PRI T1	ATM4	WAN
	Single	Single		
IP Office Essential Edition - PARTNER® Version	✗	✓	✓	✗

7.1.3 Further Information and Product Updates

Further information, including Product and Reference Manual updates, can be obtained from Avaya's Dealers and Distributors, or from Avaya's web site: <http://www.avaya.com>.

This guide is also available from the Avaya's support web site: <http://support.avaya.com>.

Support Telephone Numbers

For initial help and support, contact your distributor/supplier. The following contact points are for Avaya authorized partners.

- In the USA only
Avaya provides a toll-tree Customer Helpline 24 hours a day:
 - Name: Avaya Technical Support Organization (TSO)
 - Customer Helpline: 1 800 628-2888
 - Address: 8744 Lucent Blvd., Highlands Ranch, Colorado, 80129 USA
 - URL: <http://support.avaya.com>
If you need assistance when installing, programming, or using your system, call the Helpline or your Avaya representative. Consultation charges may apply.
- Outside the USA
If you need assistance when installing, programming, or using your system, contact your Avaya representative.
 - URL: <http://support.avaya.com>

7.1.4 Compliance with FCC Rules

Transmit and Receive Gain Settings for PRI/T1 and Analog Ports

The Gain settings are password controlled for use by qualified installation personnel only and must not be made available to the end user. The default gain settings of 0dB ensures compliance with FCC part 68 section 68.308(b)(5) and TIA/EIA-IS-968 Section 4.5.2.5. "Through transmission amplification from ports for the connection of separately registered equipment or from other network connection ports". Gain setting adjustment by unqualified personnel may result in violation of the FCC rules. Qualified personnel may adjust gain settings above these levels only where:

1. Measurement is made to ensure that the power levels sent to line at each network interface connected does not exceed the maximum levels specified in FCC part 68 section 68.308(b) and TIA/EIA-IS-968 Section 4.5 for that specific interface type.
2. Where gain adjustment away from the default values are made, precautions should be taken to ensure that the connection of terminal equipment is controlled by qualified installation personnel.

7.1.5 Port Safety Classification

The Avaya IP Office Essential Edition - PARTNER Version system has the following ports which are classified as follows:

Port Name	Port Description	Port Classification
PRI port	PRI ISDN connection (NET)	TNV (Operating within the limits of SELV)
Analog ports	Two wire analog trunk	TNV3

Power fail ports	Two wire analog trunk	TNV3
DTE port	Async Data connection.	SELV
Analog Telephone Ports	Telephone Extension ports	TNV2
Digital Telephone Ports	Telephone Extension ports	SELV
WAN port (not used)	WAN connection (NET).	SELV
LAN ports	10/100 BaseT attachment to LAN.	SELV
Expansion ports	Expansion Module connector.	SELV
Audio port	Connector for Music on Hold.	SELV
External Control port	Connector for Controlling Ancillary circuits.	SELV
DC Input port	Connector for DC input power.	SELV

Interconnection circuits shall be selected to provide continued conformance with the requirements of EN 609050: 1992/ A3: 1995 clause 2.3 for SELV circuits and with the requirements of clause 6 for TNV circuits, after connections between equipment.

7.1.6 EMC Directive

889/336/ EEC (EMC Directive) CISPR 22: 1993 including A1 + A2, AS/NZ 3548: 1995 (ROW)

- **WARNING**

This is a class A product. In a domestic environment this product may cause radio interference in which case the user may be required to take adequate measures.

Federal Communications Commission (FCC)

This equipment has been tested and found to comply with the limits for a Class A digital device, pursuant to Part 15 of the FCC Rules. These limits are designed to provide reasonable protection against harmful interference when the equipment is operated in a commercial environment. This equipment generates, uses, and can radiate radio frequency energy and, if not installed and used in accordance with the instruction manual, may cause harmful interference to radio communications. Operation of this equipment in a residential area is likely to cause harmful interference, in which case the user will be required to correct the interference at his or her own expense.

Canadian Department of Communications (DOC)

"NOTICE: This equipment meets the applicable Industry Canada Terminal Equipment Technical Specifications. This is confirmed by the registration number. The abbreviation, IC, before the registration number signifies that registration was performed based on a Declaration of Conformity indicating that Industry Canada technical specifications were met. It does not imply that Industry Canada approved the equipment."

7.2 Regulatory Instructions for Use

7.2.1 Canada

This equipment meets the applicable Industry Canada Terminal Equipment Technical Specifications. This is confirmed by the registration number. The abbreviation, IC, before the registration number signifies that registration was performed based on a Declaration of Conformity indicating that Industry Canada technical specifications were met.

It does not imply that Industry Canada approved the equipment.

"NOTICE: The Ringer Equivalence Number (REN) for this terminal equipment is 1. The REN assigned to each terminal equipment provides an indication of the maximum number of terminals allowed to be connected to a telephone interface. The termination on an interface may consist of any combination of devices subject only to the requirement that the sum of the Ringer Equivalence Numbers of all the devices does not exceed five."

7.2.2 FCC Notification

This equipment is registered with the ACTA (Administrative Council for Terminal Attachments) in accordance with FCC Part 68 of its rules. In compliance with those rules, you are advised of the following:

- Means of Connection
Connection of this equipment to the telephone network shall be through a standard network interface jack. Connection to 1.544-Mbps digital facilities must be through a USOC RJ48C. Connection to the Analog Trunk facilities must be through a USOC RJ45S.
- Notification to the Telephone Companies
Before connecting this equipment, you or your equipment supplier must notify your local telephone company's business office of the telephone number or numbers you will be using with this equipment.
- The facility interface codes (FIC) for 1.544-Mbps digital connection are 04DU9.BN, 04DU9.DN, 04DU9.IKN, 04DU9.ISN.
- The facility interface code (FIC) for analog trunk connection are OL13A, OL13B, OL13C, 02AC2, 02LA2, 02LB2, 02LC2, 02LR2, 02LS2.
- The facility interface code (FIC) for analog trunk connection are OL13A, OL13B, OL13C, 02AC2, 02GS2, 02LA2, 02LB2, 02LC2, 02LR2, 02LF2.
- The Service Order Code (SOC) for 1.544-Mbps digital connection is 6.OY.
- The Service Order Code (SOC) for analog trunk connection is 9.OY.
- Disconnection
You must also notify your local telephone company if and when this equipment is permanently disconnected from the line or lines.
- Hearing Aid Compatibility
The custom telephone sets for this system are compatible with inductively coupled hearing aids as prescribed by the FCC.

Ringer Equivalence Number (REN). The REN is used to determine the number of devices that may be connected to the telephone line. Excessive RENs on the line may result in the devices not ringing in response to an incoming call. In most, but not all, areas, the sum of the RENs should not exceed five. To be certain of the number of devices that may be connected to the line, as determined by the total RENs, contact the local telephone company to determine the maximum REN for the calling area.

Index

-
- .bin files 23
- A**
- Administration 88
- Administration tool 28
- Analog phone card 51
- Applications 75
- Assembling telephones 41
- Associated documents 7
- Aux button 47, 69, 91
- Availability of equipment 9
- Avaya University 28
- B**
- Backup 14, 90, 92, 93, 102
- Barrier boxes 72, 73
- Base card 49
 - analog phone 19, 49
 - ATM combination 19, 49
 - digital station 19, 49
 - ETR 19, 49
- BM32 extension 22, 61, 70
- Book structure 8
- Bulletin technical 7, 23, 28, 30, 32, 75, 98, 99
- C**
- Cable 16
 - 9-way DTE 32
 - access 31
 - clearance 31
 - LAN 32
 - maximum distances 32
 - RJ45 71
 - standard IP Office 32
- Cabling 71
- Call barring 102
- Call logging 78
- Capacity 46
- Card
 - analog phone 49, 51
 - analog trunk 20, 55
 - base 16, 19, 49
 - combination 16, 19, 49, 54
 - daughter 16, 20, 50, 55
 - digital station 19, 49, 50
 - DS 49
 - ETR6 19, 49, 52
 - installation 37
 - PRI 20, 55
 - SD 16
 - SIP trunk 21
 - trunk 16, 20, 55
- Card SD
 - actions 89
 - administration 89
 - booting from 91
 - content 48
 - copy 94
 - optional 18, 48, 90, 91
 - recreating 92
 - reinsertion 91
 - removal 18, 89, 91
 - SD 91
 - shutdown 89, 91
 - start 89
- system 93, 94
- Change
 - IP address 100
 - password 28
 - system components 95
- Checklist 29
- Clock signal 94
- Component descriptions 46
- Conference parties 46
- Connection
 - grounding 33
 - handsets 41
 - out of building 71
- Connector
 - phone 32
 - RJ11 32
- Control unit 46
 - audio connector 47
 - dimensions 17
 - grounding 33
 - PARTNER System Unit 17
 - rear panel 47
 - reset 47
 - ventilation space 31
- Copying files 94
- Core software 23, 99
- CPU 40
- Customer handover 42
- D**
- Daughter cards
 - analog trunk 20, 55, 56
 - PRI trunk 56
 - PRI-U trunk 20, 55
 - trunk 20, 55
- DECT 30
- Default password 88
- DHCP settings 88
- Dial plan 22
- Digit sequence 22
- Digital station card 50
- Directories 90
- Document history 8
- Documentation 30
- Dynamic system files 90
- E**
- Earthing 34, 73
- EMC Cautions
 - Canadian Department of Communications 112
 - EMC Caution for China 112
 - Federal Communications Commission 112
- Environmental requirements 29, 34
- Equipment
 - availability 9
 - disposal 8
 - protective 33
 - servicable 9
- Expansion Module 16, 57
 - connections 57
 - digital station 21, 57
 - external 21
 - phone 21, 59
- Extension ID 95
- External module 21
- External trunk configuration 94

F

Faulty Units 9
FCC Rules 111
Feature keys 18
Features, PARTNER 14
File
 copy 94
 dynamic system 90
Fitting daughter cards 37
Fixed buttons 65

G

General information
 content 8
 repair 9
 system description 14
 training 10
 web sites 9
Getting started 28
Ground symbols 33
Grounding control units 33

H

Hazard Symbols 110
Hazardous Substances 8

I

Incoming call routes 41
Initial configuration 88
Installation 28, 36
 rack mounting 34
 wall mounting 35
Installer 28
Introduction 7
IP address 100
IP Office
 base cards 16
 combination cards 16
 control unit 16
 installation 28
 system 16
IP Office Operation in
 Canada 113
 USA 113

K

Knowledge base 30

L

LAN 40, 75, 81
Laptop 40
LED 40
Level of software 23
Licenses 18, 76, 77, 97
Lightening protection 71, 110
Line appearance 63

M

Manager application 28, 75
Message waiting indicator 63
Module
 testing 41
 trunk interface 111
Monitor application 75, 76
Mounting
 clearances 34, 35
 rack 34
 wall 34, 35

O

Other documents 7
Out of building connection 71

P

Packaging 29
PARTNER features 14
Parts check 29
Parts required 32
Password
 change 28
 default 88
 system 88
Phone
 (POT) Port 82
 1403 63
 1408 62
 1416 61
 3920 68
 add ons 70
 analog 72
 analog barrier box 72
 assembling 41
 connectors 32
 DECT 68
 DS 71
 ETR18 67
 ETR18D 65
 ETR34 66
 ETR34D 64
 ETR6 67
 ETR6D 65
 IROB 71
 POTS 69
 supported 22, 61
 system shutdown 101
 wireless 68
Phone (POT) Port 82
Pillars support 37
Plan, dial 22
Port
 analog 78
 audio 78
 BRI 78
 Cable requirement 84
 DC I/P 78
 digital 49
 DS 57, 78
 DTE Settings 84
 expansion 78
 EXT O/P 78
 LAN 78
 PF 78
 Phone (POT) 78, 82
 PRI 78
 RJ45 49
 RS232/DTE 78, 84
 Safety Classification 111
 USB 78
 WAN 78
Power
 cord 16
 outlet 23
 supplies 16
 supply 23
Power supply

- Power supply
 - backup 24
 - uninterruptible 24
- Preassigned features 14
- PRI channels 55
- Primary folder 92, 93, 94
- Product support 9
- Protective equipment 33
- PSU 23
- R**
- Rack mounting 34
- Rear connections 47
- Rebooting the system 102
- Reliable earthing 34
- Remote administration 88
- Remote password 88
- Required tools 32
- Requirements
 - cable access 31
 - cable clearance 31
 - space 31
- Restore 93
- RFRFCC 21
- RoHS 8
- S**
- Safety 29
- SAP codes 23
- SD card 18, 89, 90, 91
 - format 48
 - inserting 40
 - management 88
 - removal 48
- Servicable equipment 9
- Signal clock 94
- Signoff 42
- SIP trunk card 21
- Slot availability 14
- Slot numbering 49
- SMDR 78
- SOE Installation 97
- Software level 23
- Software upgrade 99
- Space Requirements 31
- SSA 75, 97
- Starting 40
- Support 30
- Support pillars 37
- Supported phones 22, 61
- Surge protector 16
- System
 - administration 88
 - capacity 14
 - change IP address 100
 - changes to 88
 - changing components 95
 - constraints 14
 - details of components 46
 - reboot 102
 - server 17
 - shutdown 101
 - status application 76
 - upgrade 98
- System status application 75, 97
- T**
- TAPI 75
- TAPI application 77
- Technical bulletin 7, 23, 30, 32, 75, 98, 99
- Telephone
 - assembling 41
- Testing modules 41
- Tools 37
- Tools required 32
- towerMAX device 71
- Training courses 10
- Trouble shooting 97
- Trunk
 - cards 55
 - clock source 88
 - external configuration 94
 - interface modules 111
 - prefixes 88
 - provider 21
 - unused 88, 95
- U**
- Units faulty 9
- University, Avaya 28
- Unpacking 29
- Upgrade 23, 98
- Upgrade software 23, 99
- UPS 24
- V**
- Voicemail 46
- W**
- Wall mounting 29, 34, 35
- Web Sites 9

Performance figures and data quoted in this document are typical, and must be specifically confirmed in writing by Avaya before they become applicable to any particular order or contract. The company reserves the right to make alterations or amendments to the detailed specifications at its discretion. The publication of information in this document does not imply freedom from patent or other protective rights of Avaya or others.

Intellectual property related to this product (including trademarks) and registered to Lucent Technologies have been transferred or licensed to Avaya.

All trademarks identified by the ® or ™ are registered trademarks or trademarks, respectively, of Avaya Inc. All other trademarks are the property of their respective owners.

This document contains proprietary information of Avaya and is not to be disclosed or used except in accordance with applicable agreements.

Any comments or suggestions regarding this document should be sent to "wgctechpubs@avaya.com".

© 2010 Avaya Inc. All rights reserved.

Avaya
Unit 1, Sterling Court
15 - 21 Mundells
Welwyn Garden City
Hertfordshire
AL7 1LZ
England.

Tel: +44 (0) 1707 392200
Fax: +44 (0) 1707 376933

Web: <http://marketingtools.avaya.com/knowledgebase>